

Easy-to-use Controllers for Operators

**Compact Body
Large Display
48 x 48mm**



UT130



UT150

**Compact Body
Full Functions
48 x 48mm**

**Simple Operation
Less Space
48 x 96mm**



UT152



UT155

**Simple Operation
Large Display
96 x 96mm**

Features

- Large display
- Simple operation
- Available 24V AC/DC power supply
- Dynamic Auto Tune control
- Full alarm functions
- Retransmission outputs
- Timer function
- RUN / STOP switching

INTRODUCTION

The UT100 Series controllers are the controllers mainly for temperature control.

The UT100 Series controllers are developed using the newest technology based on the Yokogawa Group's experience for control for years and results cultivated from many applications.

■ Document Structure

This document describes the functions of UT100 Series controllers.

The document consists of the following chapters.

Chapter 1: This chapter explains what a temperature controller is.

Chapter 2: This chapter explains the model and suffix codes of the controller and the information for ordering.

Chapter 3: This chapter explains the Parameter Flowchart and Parameter Lists of UT100 Series controllers.

Chapter 4: This chapter explains the basic operating procedures when using a UT100 Series controller at first.

Chapter 5: This chapter explains the applied operations not described in Chapter 4.

Chapter 6: This chapter explains the basic functions of UT100 Series controllers.

Chapter 7: This chapter explains a troubleshooting for errors before/during operation.

Chapter 8: This chapter explains the installation, wiring and hardware specifications.

■ Intended Readers

This document is intended to the following personnel:

- Instrumentation engineers or electrical engineers planning to use a temperature controller
- Instrumentation engineers or electrical engineers who would like to know the outline of a temperature controller

■ Trademark Acknowledgements

- The company and product names referred to in this document are either trademarks or registered trademarks of their respective holders.

UT130, UT150/UT152/UT155 Temperature Controller

TI 05C01E02-01E 1st Edition

CONTENTS

| | |
|---|------------|
| INTRODUCTION | i |
| 1. DESCRIPTION OF TEMPERATURE CONTROL | 1-1 |
| 2. INFORMATION TO ORDER A CONTROLLER | 2-1 |
| 2.1 Model and Suffix Codes | 2-1 |
| 2.2 Mandatory Items to Specify | 2-5 |
| 2.3 Optional Suffix Codes to Specify | 2-5 |
| 2.4 Other Items to Specify | 2-6 |
| 2.5 User's Manual | 2-8 |
| 3. NAMES AND FUNCTIONS OF EACH PART / PARAMETER | 3-1 |
| 3.1 UT130 Names and Functions of Each Part (Principles of Key Operation) | 3-1 |
| 3.2 UT130 Parameter Flowchart and Description | 3-2 |
| 3.3 UT150/UT152/UT155 Names and Functions of Each Part (Principles of Key Operation) | 3-6 |
| 3.4 UT150/UT152/UT155 Parameter Flowchart and Description | 3-8 |
| 4. BASIC OPERATIONS | 4-1 |
| 4.1 Setting Measured Input Type and Scale (Setting First) | 4-1 |
| 4.2 Setting Control Action | 4-5 |
| 4.2.1 Selecting a Control Mode (Dynamic Auto Tune Control / PID Control / ON-OFF Control) | 4-5 |
| 4.2.2 Switching Direct / Reverse Action | 4-6 |
| 4.2.3 Setting Cycle Time (Control Output Renewal Period) | 4-8 |
| 4.3 Setting Target Setpoint (SP) | 4-9 |
| 4.3.1 Setting Target Setpoint (SP) of UT130 | 4-9 |
| 4.3.2 Setting Target Setpoint (SP) of UT150/UT152/UT155 | 4-10 |
| 4.4 Setting Alarms | 4-12 |
| 4.4.1 Setting Alarm Type and Hysteresis | 4-12 |
| 4.4.2 Setting Alarm Setpoint | 4-16 |
| 4.4.3 Heater Disconnection Alarm Function | 4-17 |

| | |
|---|------------|
| 5. APPLIED OPERATIONS | 5-1 |
| 5.1 Changing Measured Input Type and Scale | 5-1 |
| 5.2 Correcting Measured Input Value | 5-1 |
| 5.3 Reducing Input Variations | 5-2 |
| 5.4 Setting Maximum and Minimum Values of Target Setpoint Range | 5-2 |
| 5.5 Setting Target Setpoint Ramp Rate (Rate-of-Change) | 5-3 |
| 5.6 Using Two Target Setpoints | 5-4 |
| 5.7 Retransmission of Measured Input Value in Current Signal | 5-4 |
| 5.8 Switching RUN/ STOP | 5-5 |
| 5.9 Using Timer Function (Turning on External Contact Outputs after the Set Time Elapses) | 5-6 |
| 5.10 Setting Key Lock | 5-7 |
| 5.11 Selecting Priority of PV/SP Display at Power on (for UT130 Only) | 5-8 |
| 5.12 Performing Heating/Cooling Control | 5-8 |
| 5.13 Communicating with PC or PLC | 5-9 |
| 6. DESCRIPTION OF EACH FUNCTION | 6-1 |
| 6.1 ON/OFF Control | 6-1 |
| 6.1.1 ON/OFF Control and Hysteresis | 6-1 |
| 6.1.2 ON/OFF Control Application Example | 6-1 |
| 6.2 Proportional (P) Action | 6-2 |
| 6.2.1 Differences between ON/OFF Action and Proportional Action | 6-2 |
| 6.2.2 Proportional Band (P) Details | 6-2 |
| 6.2.3 Tuning the Proportional Band | 6-3 |
| 6.3 Integral (I) Action | 6-4 |
| 6.3.1 Integral Time (I) | 6-4 |
| 6.3.2 Tuning the Integral Time | 6-4 |
| 6.4 Derivative (D) Action | 6-5 |
| 6.4.1 Derivative Time (D) | 6-5 |
| 6.4.2 Tuning the Derivative Time | 6-5 |
| 6.5 Dynamic Auto Tune Control and PID Control | 6-6 |
| 6.5.1 Dynamic Auto Tune Control | 6-6 |
| 6.5.2 Manually Tuning PID Constants | 6-7 |
| 6.5.3 PID Auto-Tuning | 6-7 |
| 6.6 Control Output | 6-8 |
| 6.6.1 Time Proportional PID Output (Relay Output / Voltage Pulse Output) | 6-8 |
| 6.6.2 Cycle Time | 6-8 |
| 6.6.3 Continuous PID Output (4 to 20mA DC) | 6-9 |
| 6.7 Overshoot Suppressing Function "SUPER" | 6-10 |
| 6.7.1 "SUPER" Operating Principles | 6-10 |
| 6.7.2 Effects of "SUPER" | 6-10 |

| | |
|---|------------|
| 7. TROUBLESHOOTING | 8-1 |
| 8. INSTALLATION AND HARDWARE SPECIFICATIONS | 8-1 |
| 8.1 Installation | 8-1 |
| 8.2 Panel Cutout Dimensions and External Dimensions | 8-3 |
| 8.3 Wiring | 8-7 |
| 8.4 Hardware Specifications | 8-12 |

Blank Page

1. DESCRIPTION OF TEMPERATURE CONTROL

■ Temperature Controller

The temperature controller is used to keep the fixed temperature of such as a furnace (controlled object). In general, the temperature controller has temperature indicating display and setpoint setting display, generates a control signal according to the difference between a indicating value (measured temperature value) and SP to finally make the temperature agree with SP.

Sensors such as thermocouple (TC) or RTD can be connected for measuring a temperature. And output types such as relay output or current output (4 to 20mA) are prepared according to the operating terminal (heater, valve, and the like) that actually controls a temperature.

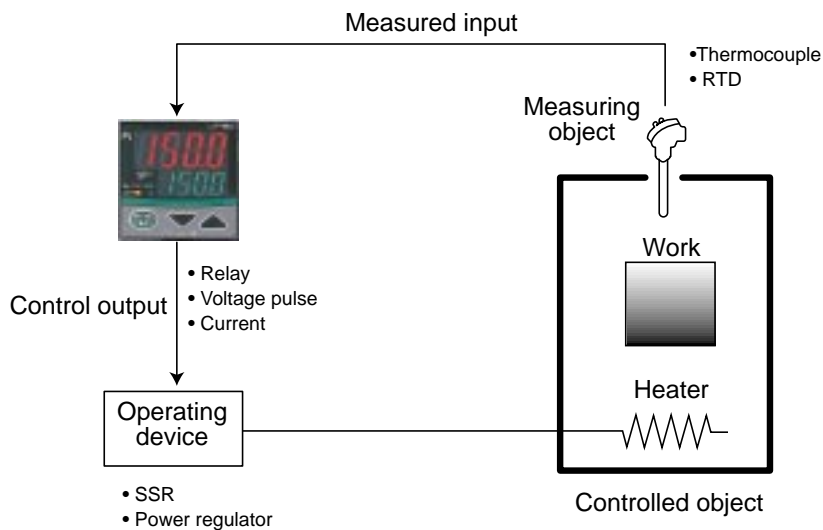

■ Types of Temperature Control Action

ON/OFF action is the simplest action among the control actions. ON/OFF action of the internal thermostat keeps the optimum temperature. But the temperature control output fluctuates in the fixed cycle with ON/OFF action. If this temperature cycle causes a problem, the control action that changes the output in proportion to the deviation (the difference between the target setpoint and present value) can give a better control performance. Thus the control action that moves the function part in proportion to the deviation is referred to as a proportional action (P action). But a steady-state deviation (offset) is inherently unavoidable with proportional action alone. Though the manual reset can remove the offset, the same thing can be done using the control action together with the Integral action (I action) that will integrate the deviation as long as the deviation exists. This combination is referred to as a proportional-plus-integral action (PI action). It is the popular control method among the process control actions.

On the other hand, the derivative action (D action) is the action that changes the output in proportion to the rate-of-change of deviation. Since the output of derivative action depends on not the amount of deviation but its rate-of-change, the larger the rate-of-change is, the more intensive corrective action the controller takes to correct the process response in advance. Setting each optimum value with the PID action consisted of these three actions enables a stable control quickly.

■ Dynamic Auto Tune Control

The Dynamic Auto Tune Control is the function to automatically determine the optimum PID constants for continuing a good control when the controller is turned on or the control conditions are unstable. This control method is gentle to the controlled object itself because a disturbance needs not to be set forcibly like Auto tuning.





In Dynamic Auto Tune Control, the controller automatically monitors the behavior and determines the optimum PID constants when (1) at power on, (2) the output travels up to 100% or down to 0% and remains there after changing a setpoint, (3) process begins oscillating by disturbance and the like. The principle of Dynamic Auto Tune Control can be relied on because it is based on Gegalr/Nichols's control method.

Refer to "6.5.1 Dynamic Auto Tune Control" on Page 6-6.

2. INFORMATION TO ORDER A CONTROLLER

2.1 Model and Suffix Codes

The models and suffix codes of UT130, UT150/UT152/UT155 standard types are as follows:

| Type | External Appearance | Options | Output | Standard Type Model | | | |
|--|---|---|-----------------------------|-----------------------|-----------------------|----------------------|----------------|
| UT130 48x48x100mm 3-digit display Number of SP: 2 |  | Without alarm | Without other options | Relay output | UT130-RN | | |
| | | | | Voltage pulse output | UT130-VN | | |
| | | With 2 alarms | Without other options | Without other options | Relay output | UT130-RN/AL | |
| | | | | | Voltage pulse output | UT130-VN/AL | |
| | | | With communication | Without other options | Relay output | UT130-RN/AL/RS | |
| | | | | | Voltage pulse output | UT130-VN/AL/RS | |
| UT150 48x48x100mm 4-digit display Number of SP: 2 |  | Without alarm | Without other options | Relay output | UT150-RN | | |
| | | | | Voltage pulse output | UT150-VN | | |
| | | | | Current output | UT150-AN | | |
| | | | | Relay output | UT150-RN/AL | | |
| | | | | Voltage pulse output | UT150-VN/AL | | |
| | | | | Current output | UT150-AN/AL | | |
| | | With 2 alarms | Without other options | Without other options | Relay output | UT150-RN/AL/RET | |
| | | | | | Voltage pulse output | UT150-VN/AL/RET | |
| | | | | | Current output | UT150-AN/AL/RET | |
| | | | With external contact input | Without other options | Without other options | Relay output | UT150-RN/AL/EX |
| | | | | | | Voltage pulse output | UT150-VN/AL/EX |
| | | | | | | Current output | UT150-AN/AL/EX |
| | | With communication | Without other options | Without other options | Relay output | UT150-RN/AL/RS | |
| | | | | | Voltage pulse output | UT150-VN/AL/RS | |
| | | | | | Current output | UT150-AN/AL/RS | |
| | | With retransmission output/external contact input | Without other options | Without other options | Relay output | UT150-RN/AL/RET/EX | |
| | | | | | Voltage pulse output | UT150-VN/AL/RET/EX | |
| | | | | | Current output | UT150-AN/AL/RET/EX | |
| UT152 48x96x100mm 4-digit display Number of SP: 2 |  | Without alarm | Without other options | Relay output | UT152-RN | | |
| | | | | Voltage pulse output | UT152-VN | | |
| | | | | Current output | UT152-AN | | |
| | | | | Relay output | UT152-RN/AL | | |
| | | | | Voltage pulse output | UT152-VN/AL | | |
| | | | | Current output | UT152-AN/AL | | |
| | | With 2 alarms | Without other options | Without other options | Relay output | UT152-RN/AL/RET | |
| | | | | | Voltage pulse output | UT152-VN/AL/RET | |
| | | | | | Current output | UT152-AN/AL/RET | |
| | | | With external contact input | Without other options | Without other options | Relay output | UT152-RN/AL/EX |
| | | | | | | Voltage pulse output | UT152-VN/AL/EX |
| | | | | | | Current output | UT152-AN/AL/EX |
| | | With communication | Without other options | Without other options | Relay output | UT152-RN/AL/RS | |
| | | | | | Voltage pulse output | UT152-VN/AL/RS | |
| | | | | | Current output | UT152-AN/AL/RS | |
| | | With retransmission output/external contact input | Without other options | Without other options | Relay output | UT152-RN/AL/RET/EX | |
| | | | | | Voltage pulse output | UT152-VN/AL/RET/EX | |
| | | | | | Current output | UT152-AN/AL/RET/EX | |
| UT155 96x96x100mm 4-digit display Number of SP: 2 |  | Without alarm | Without other options | Relay output | UT155-RN | | |
| | | | | Voltage pulse output | UT155-VN | | |
| | | | | Current output | UT155-AN | | |
| | | | | Relay output | UT155-RN/AL | | |
| | | | | Voltage pulse output | UT155-VN/AL | | |
| | | | | Current output | UT155-AN/AL | | |
| | | With 2 alarms | Without other options | Without other options | Relay output | UT155-RN/AL/RET | |
| | | | | | Voltage pulse output | UT155-VN/AL/RET | |
| | | | | | Current output | UT155-AN/AL/RET | |
| | | | With external contact input | Without other options | Without other options | Relay output | UT155-RN/AL/EX |
| | | | | | | Voltage pulse output | UT155-VN/AL/EX |
| | | | | | | Current output | UT155-AN/AL/EX |
| | | With communication | Without other options | Without other options | Relay output | UT155-RN/AL/RS | |
| | | | | | Voltage pulse output | UT155-VN/AL/RS | |
| | | | | | Current output | UT155-AN/AL/RS | |
| | | With retransmission output/external contact input | Without other options | Without other options | Relay output | UT155-RN/AL/RET/EX | |
| | | | | | Voltage pulse output | UT155-VN/AL/RET/EX | |
| | | | | | Current output | UT155-AN/AL/RET/EX | |

Note 1: Heating/cooling control type is available in addition to the standard type described above. Refer to the following pages.
 Note 2: For options, the combinations other than those mentioned above are available. Refer to the following pages.

■ Standard type

● UT130 Standard Type: Model and Suffix Codes

Model and Suffix Codes

| Model | Suffix codes | Description |
|----------------|--------------|---|
| UT130 | | Temperature controller (48 x 48 x 100mm) |
| Control output | -R | Relay output (time-proportional PID or on/off control) |
| | -V | Voltage pulse output (time-proportional PID control) |
| Fixed | N | Fixed |
| Options | /AL | Alarm outputs (2 points) (Note1) |
| | /HBA | Heater disconnection alarm (includes the function of "/AL" option) (Note 1) |
| | /RS | Communication function (Note 2) |
| | /V24 | Power Supply 24V DC / 24V AC |

- Check the package contents against the list below.
- Temperature controller (of ordered model) 1
 - Mounting bracket 1
 - User's Manual (IM 05C01E02-01E) 1

Note 1: The "/AL" and "/HBA" options cannot be specified at the same time. The "/HBA" option includes the function of "/AL" option.

Note 2: When specifying the "/RS" option, be sure to order the required number of copies of the Communication Functions User's Manual (IM05C01E12-10E) separately. (See Page 2-8.)

● UT150 Standard Type: Model and Suffix Codes

Model and Suffix Codes

| Model | Suffix Codes | Description |
|----------------|--------------|---|
| UT150 | | Temperature controller (48 x 48 x 100 mm) |
| Control output | -R | Relay output (time-proportional PID or on/off control) |
| | -V | Voltage pulse output (time-proportional PID control) |
| | -A | 4 to 20mA output (current PID) (Note1) |
| Fixed | N | Fixed |
| Option | /AL | Alarm outputs (2 points) (Note2) |
| | /HBA | Heater disconnection alarm (includes the function of "/AL" option) (Notes 2 and 3) |
| | /EX | SP1/SP2 switching, starting of timer, and RUN/STOP switching by external contacts (Notes 4 and 5) |
| | /RET | PV retransmission output in 4 to 20mA (Note 3) |
| | /RS | Communication function (Notes 4 and 6) |
| | /V24 | Power Supply 24V DC / 24VAC |

UT150 Table of Option Combination

| | /AL | /HBA | /EX | /RET | /RS | /V24 |
|------|-----|------|-----|------|-----|------|
| /AL | | N/A | A | A | A | A |
| /HBA | N/A | | N/A | N/A | A | A |
| /EX | A | A | | A | N/A | A |
| /RET | A | N/A | A | | A | A |
| /RS | A | A | N/A | A | | A |
| /V24 | A | A | A | A | A | |

- Check the package contents against the list below.
- Temperature controller (of ordered model) 1
 - Mounting bracket 1
 - User's Manual (IM 05C01E12-01E) 1

A : Available
N/A : Not available

Note 1: The "/HBA" option cannot be specified when selecting "4 to 20mA output" as a control output type.

Note 2: The "/AL" and "/HBA" options cannot be specified at the same time. The "/HBA" option includes the function of "/AL" option.

Note 3: The "/HBA" and "/RET" options cannot be specified at the same time.

Note 4: "/EX" and "/RS" options cannot be specified at the same time.

Note 5: Two points of external contact inputs are available. Select 2 functions among SP1/SP2 switching, starting of timer, and RUN.STOP switching.

Note 6: When specifying the "/RS" option, be sure to order the required number of copies of the Communication Functions User's Manual (IM05C01E12-10E) separately. (See Page 2-8)

● **UT152 / UT155 Standard Type: Model and Suffix Codes**

Model and Suffix Codes

| Model | Suffix codes | Description |
|----------------|--------------|---|
| UT152 | | Temperature controller (48 x 96 x 100mm) |
| UT155 | | Temperature controller (96 x 96 x 100mm) |
| Control output | -R | Relay output (time-proportional PID or on/off control) |
| | -V | Voltage pulse output (time-proportional PID control) |
| | -A | 4 to 20mA output (current PID) (Note1) |
| Fixed | N | Fixed |
| Option | /AL | Alarm outputs (2 points) (Note2) |
| | /HBA | Heater disconnection alarm (includes the function of "/AL" option) (Notes 2 and 3) |
| | /EX | SP1/SP2 switching, starting of timer, and RUN/STOP switching by external contacts (Notes 4 and 5) |
| | /RET | PV retransmission output in 4 to 20mA (Note 3) |
| | /RS | Communication function (Notes 4 and 5) |
| | /V24 | Power Supply 24V DC / 24VAC |

- Check the package contents against the list below.
- Temperature controller (of ordered model) 1
- Mounting bracket 1
- User's Manual (IM 05C01E12-01E) 1

Note 1: The "/HBA" option cannot be specified when selecting "4 to 20mA output" as a control output type.
 Note 2: The "/AL" and "/HBA" options cannot be specified at the same time. The "/HBA" option includes the function of "/AL" option.
 Note 3: Two points of external contact inputs are available. Select 2 functions among SP1/SP2 switching, starting of timer, and RUN/STOP switching.
 Note 4: When specifying the "/RS" option, be sure to order the required number of copies of the Communication Functions User's Manual (IM 05C01E12-10E) separately. (See Page 2-8)

■ **Heating/Cooling Type**

● **UT130 Heating/Cooling Type: Model and Suffix Codes**

Model and Suffix Codes

| Model | Suffix codes | Description |
|----------------------------|--------------|--|
| UT130 | | Temperature controller (48 x 48 x 100mm) |
| Control output for heating | -R | Relay output (time-proportional PID or on/off control) |
| | -V | Voltage pulse output (time-proportional PID control) |
| Control output for cooling | R | Relay output (time-proportional PID or on/off control) |
| | V | Voltage pulse output (time-proportional PID control) |
| Option | /AL | Alarm outputs (2 points) (Note1) |
| | /HBA | Heater disconnection alarm (includes the function of "/AL" option) (Notes 1 and 2) |
| | /RS | Communication function (Notes 2 and 3) |
| | /V24 | Power Supply 24V DC / 24V AC |

- Check the package contents against the list below.
- Temperature controller (of ordered model) 1
- Mounting bracket 1
- User's Manual (IM 05C01E02-01E) 1

Note 1: The "/AL" and "/HBA" options cannot be specified at the same time. The "/HBA" option includes the function of "/AL" option.
 Note 2: For heating/cooling type, the "/HBA" and "/RS" options cannot be specified at the same time.
 Note 3: When specifying the "/RS" option, be sure to order the required number of copies of the Communication Functions User's Manual (IM05C01E12-10E) separately. (See Page 2-8)

● **UT150 Heating/Cooling Type: Model and Suffix Codes**

Model and Suffix Codes

| Model | Suffix codes | Description |
|----------------------------|--------------|---|
| UT150 | | Temperature controller (48 x 48 x 100mm) |
| Control output for heating | -R | Relay output (time-proportional PID or on/off control) |
| | -V | Voltage pulse output (time-proportional PID control) |
| | -A | 4 to 20mA output (current PID) (Note1) |
| Control output for cooling | R | Relay output (time-proportional PID or on/off control) |
| | V | Voltage pulse output (time-proportional PID control) |
| | A | 4 to 20mA output (current PID) (Note1) |
| Option | /AL | Alarm outputs (2 points) (Note2) |
| | /HBA | Heater disconnection alarm (includes the function of "/AL" option) (Notes 2 and 3) |
| | /EX | SP1/SP2 switching, starting of timer, and RUN/STOP switching by external contacts (Notes 3 and 4) |
| | /RS | PV retransmission output in 4 to 20mA |
| | /V24 | Power Supply 24V DC / 24VAC |

UT150 Heating/cooling Type Table of Option Combination

| | /AL | /HBA | /EX | /RS | /V24 |
|------|-----|------|-----|-----|------|
| /AL | / | N/A | A | A | A |
| /HBA | N/A | / | N/A | N/A | A |
| /EX | A | N/A | / | N/A | A |
| /RS | A | N/A | N/A | / | A |
| /V24 | A | A | A | A | / |

- Check the package contents against the list below.
- Temperature controller (of ordered model) 1
 - Mounting bracket 1
 - User's Manual (IM 05C01E12-01E) 1

A : Available
N/A : Not available

- Note 1: The "/HBA" option cannot be specified when selecting "4 to 20mA output" as a control output type.
 Note 2: The "/AL" and "/HBA" options cannot be specified at the same time. The "/HBA" option includes the function of "/AL" option.
 Note 3: The "/HBA", "/EX" and "/RS" options cannot be specified at the same time.
 Note 4: Two points of external contact inputs are available. Select 2 functions among SP1/SP2 switching, starting of timer, and RUN/STOP switching.
 Note 5: When specifying the "/RS" option, be sure to order the required number of copies of the Communication Functions User's Manual (IM05C01E12-10E) separately. (See Page2-8)

● **UT152 / UT155 Heating/Cooling Type: Model and Suffix Codes**

Model and Suffix Codes

| Model | Suffix codes | Description |
|----------------------------|--------------|--|
| UT152 | | Temperature controller (48 x 96 x 100mm) |
| UT155 | | Temperature controller (96 x 96 x 100mm) |
| Control output for heating | -R | Relay output (time-proportional PID or on/off control) |
| | -V | Voltage pulse output (time-proportional PID control) |
| | -A | 4 to 20mA output (current PID) (Note1) |
| Control output for cooling | R | Relay output (time-proportional PID or on/off control) |
| | V | Voltage pulse output (time-proportional PID control) |
| | A | 4 to 20mA output (current PID) (Note1) |
| Option | /AL | Alarm outputs (2 points) (Note2) |
| | /HBA | Heater disconnection alarm (includes the function of "/AL" option) (Note 2) |
| | /EX | SP1/SP2 switching, starting of timer, and RUN/STOP switching by external contacts (Note 3) |
| | /RS | Communication function (Note 4) |
| | /V24 | Power Supply 24V DC / 24V AC |

- Check the package contents against the list below.
- Temperature controller (of ordered model) 1
 - Mounting bracket 1
 - User's Manual (IM 05C01E12-01E) 1

- Note 1: The "/HBA" option cannot be specified when selecting "4 to 20mA output" as control output type.
 Note 2: The "/AL" and "/HBA" options cannot be specified at the same time. The "/HBA" option includes the function of "/AL" option.
 Note 3: Two points of external contact inputs are available. Select 2 functions among SP1/SP2 switching, starting of timer, and RUN/STOP switching.
 Note 4: When specifying the "/RS" option, be sure to order the required number of copies of the Communication Functions User's Manual (IM05C01E12-10E) separately. (See Page 2-8)

2.2 Mandatory Items to Specify

Specify the following necessary items on ordering

- **Specify the power supply voltage**

When using 100 to 240V AC, no need to specify the item.

When using 24V AC/DC, specify the "/V24" option.

The frequency for both of them is 50/60Hz.

- **Specify the control output**

<Example 1>

Specify "UT150-RN" for UT150 standard type with relay output.

<Example 2>

Specify "UT150-RV" for UT150 heating/cooling type with heating-side relay output and cooling-side voltage pulse output.

2.3 Optional Suffix Codes to Specify

The following options are available. But some of them are not available according to the model. See "2.1 Model and Suffix Codes" for combinations of options.

- **When using one or two Alarms, specify the "/AL" option.**

<Example> Model and Suffix Codes: UT130-RN/AL

- **When using Heater Disconnection Alarm, specify the "/HBA" option. The "/HBA" option includes the function of "/AL" option.**

<Example> Model and Suffix Codes: UT150-RN/HBA

- **When using Retransmission Output, specify the "/RET" option.**

<Example> Model and Suffix Codes: UT150-AN/RET

- **When using two Target Setpoints, specify the "/EX" option.**

<Example> Model/Suffix Codes: UT150-RN/EX

- **When using Timer Function, specify the "/AL /EX" or "/HBA /EX" options.**

<Example> Model/Suffix Codes: UT150-VN/AL/EX

- **When using RUN/STOP Switching Function, specify the "/EX" option.**

<Example> Model/Suffix Codes: UT150-RN/EX

- **When using Communication Function, specify the "/RS" option.**

<Example> Model/Suffix Codes: UT150-RN/RS

2.4 Other Items to Specify

■ Quality Inspection Certificate (QIC) and Traceability

The Quality Inspection Certificate (QIC) of the product at shipping is prepared.

And the Traceability, which certifies that the measuring instruments and generator used for the product inspection conforms to the inspection of national standards, is also prepared.

● Quality Inspection Certificate(QIC)

Model: DOCTC

● Calibration certificate (traceability)

“Traceability declaration to the national standards” and “Explanation of the Yokogawa’s internal system for traceability”

Model: Q62188-B

■ Auxiliary Equipment and Spare Parts

● 250Ω Resistor

When a measured input signal is 4 to 20mA DC, the temperature controllers (UT150/UT152/UT155) receive it after converting to a 1 to 5V DC signal.

| Model | Description |
|------------|---|
| X010-250-2 | Resistor with M3.5 crimp-on terminal lugs |

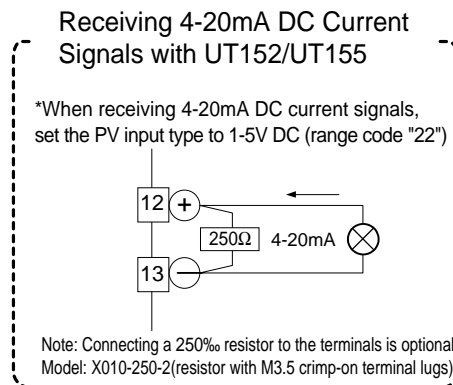
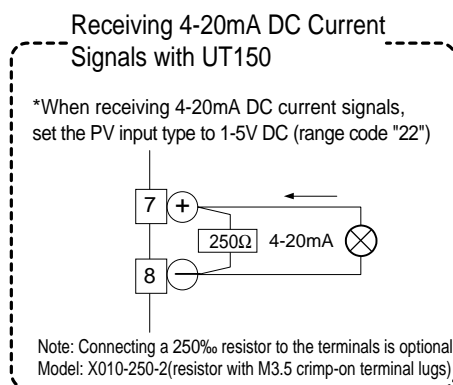

● Heater Disconnection Sensor (for 1 to 80A)

The heater current sensor used here is the “CTL-6-S-H” or “CTL-12-S36-8” sensor of U.R.D., Ltd.

This sensor is to be purchased by the users themselves.

Model: CTL-6-S-H or CTL-12-S36-8

● Terminal Cover

| Model | Description |
|---------|---|
| L4000FB | Terminal cover for models UT130 and UT150 (1 set) |
| T9115YE | Terminal cover for model UT152 (1 piece) |
| T9115YD | Terminal cover for model UT155 (1 piece) |

● Mounting Bracket

| Model | Description |
|---------|---|
| L4000FA | Mounting bracket for models UT130 and UT150 (1 piece) |
| T9115NK | Mounting bracket for model UT152 (1 set) |
| T9115NL | Mounting bracket for model UT155 (1 set) |

■ Measured Input Type, Scaling and Direct/Reverse Action can be Specified on Ordering

Measured input type, displayed scale at voltage input, and direct/reverse action for the temperature controller can be specified on ordering.

| Items to specify | Description |
|----------------------------|--|
| Measured input type | Specify "1" to "7", "12", "13", and "15 to "19" for UT130. Specify "1" to "23" for UT150/UT152/UT155. If no input type is specified at the time of ordering, the temperature controller is shipped with the parameter set to OFF (unidentified). In this case, set the input type on customer side. See "4.1 Setting Measured Input Type and Scale (Setting First)" for details. |
| Scaling (at voltage input) | The displayed scale can be specified when specifying "20" to "23" for UT150/UT152/UT155. If no scaling is specified, the temperature controller is shipped with the parameter set to "0.1 to 100.0". |
| Direct/reverse action | Specify "1" for direct action. If no action is specified, the temperature controller is shipped with the parameter set to "0" (reverse action). |

2.5 User's Manual

User's Manuals in A-2 size and A-4 size are prepared.

User's Manuals supplied along with the product is in A-2 size. Both Manuals in A-4 size and A-2 size have the same contents except for their appearances.

When specifying the "/RS" option, be sure to order the required number of copies of Communication Functions User's Manual separately.

The following User's Manuals can be purchased separately.

A4-size Manual

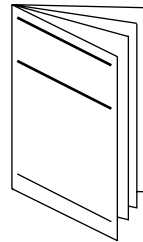

- **User's Manual for UT130 (A4 size)**

Document Number: IM05C01E02-41E

- **User's Manual for UT150/UT152/UT155 (A4 size)**

Document Number: IM05C01E12-41E

- **Communication Functions User's Manual for UT130, UT150/UT152/UT155 (A4 size)**

Document Number: IM05C01E12-10E

3. NAMES AND FUNCTIONS OF EACH PART / PARAMETER

3.1 UT130 Names and Functions of Each Part (Principles of Key Operation)

SP display lamp (orange)

- Lit when SP is displayed or being changed.
- Flashes slowly (approx. once every second) when a parameter code is displayed.
- Flashes fast when a parameter value is being changed.

Data display (red)

- In the operating display, either PV (measured value) or SP (target setpoint) is indicated. Which parameter takes precedence over the other depends on the parameter "DSP" value.
- In the parameter setting display, either the parameter codes or parameter value is indicated.
- If an error occurs, the error code is displayed.

Output (OUT) display lamps (Left: orange; right: green)

- Lit while control output is being output. Flashes according to the control output value during time-proportional output. (Flashes slowly when control output value is small; flashes fast when control output value is large.)
- The left lamp lights up in orange during control output of standard type.
- In heating/cooling control, the left lamp lights up in orange when the heating-side output is active; while the right lamp lights up in green when the cooling-side output is active.





Alarm 1 (AL1) / Alarm 2 (AL2) lamps (red)

- AL1: Lit when the alarm 1 is activated.
- AL2: Lit when the alarm 2 is activated.

SET /ENT key (data registering key)

- In the operating display, it switches between the PV (measured value) and SP (target setpoint) displays.
- Registers the data value changed using the data change keys.
- Switches between operating displays or parameter setting display sequentially.
- Pressing the key for 3 seconds or more in the operating display retrieves the operating parameter setting display. You can transfer to the setup parameter setting display from the operating parameter setting display.
- Pressing the key for 3 seconds or more in either an operating or setup parameter setting display transfers back to the operating display.

Data change keys

- When PV is displayed in the operating display, a press of the  or  key switches to the SP display.
- When a parameter code is displayed, pressing either key once displays the parameter value (which can then be changed).
- Changes SP and the parameter values.
- Pressing the  key decreases the data value and pressing the  key increases it. Holding down the key will gradually increase the speed of the change.

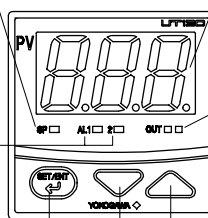

3.2 UT130 Parameter Flowchart and Description

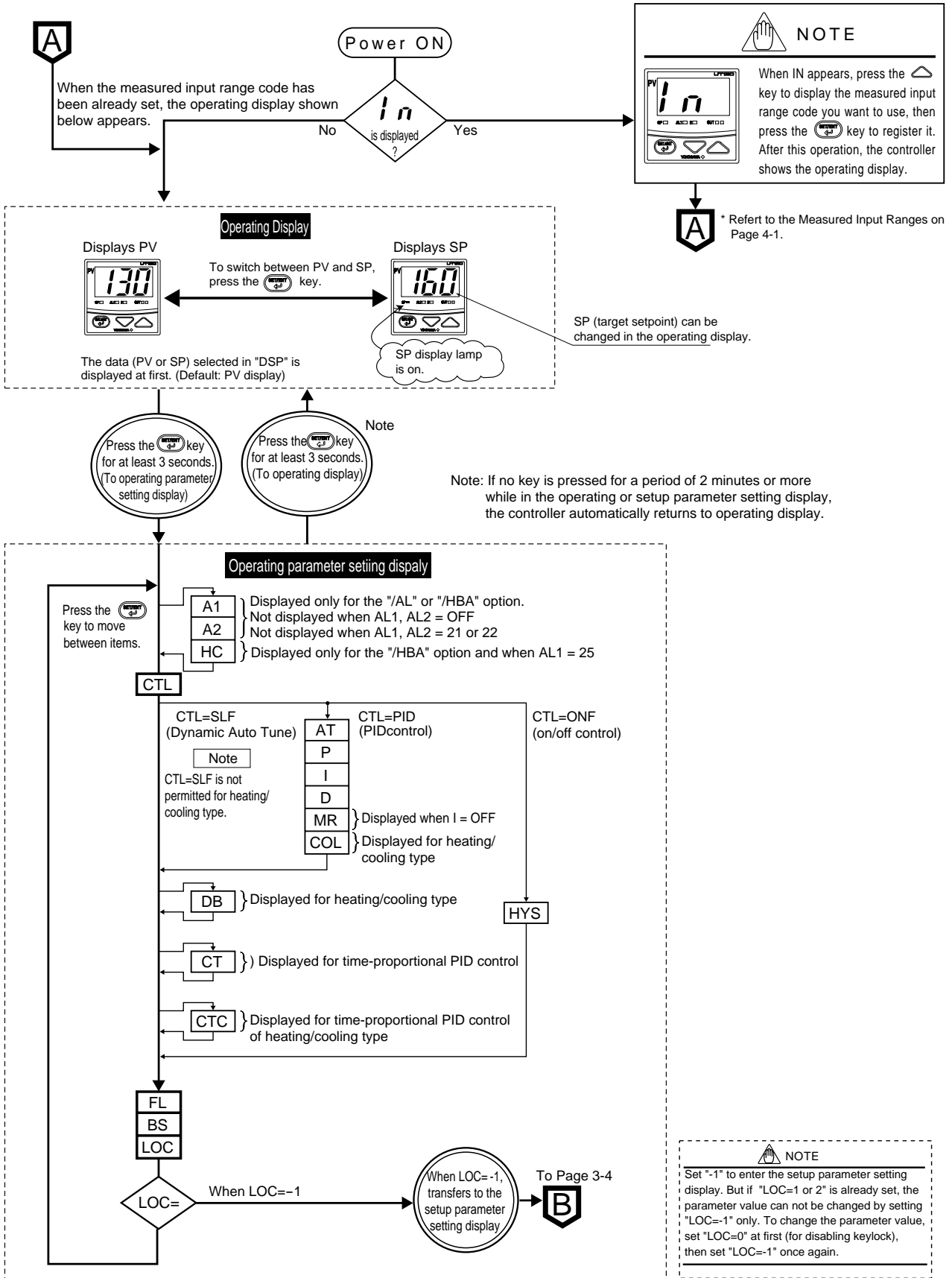

(1) Target Setpoint (SP)

| Code | Name | Setting range and unit | Default | User setting | Reference page |
|--------------------|-----------------|--|---------|--------------|----------------|
| (SP value display) | Target setpoint | Minimum value (SPL) to maximum value (SPH) of target setpoint range Unit: °C/°F | SPL | | P.4-9 |

Numbers in () are the parameter setpoints that apply when the communication function is used.
Ex. OFF(0), ON(1)

(2) Operating Parameters: Parameters changed rather frequently during operation.

| Code | Name | Setting range and unit | Default | User setting | Reference page |
|------|---|---|--|--------------|----------------------------|
| A1 | Alarm 1 setpoint | <ul style="list-style-type: none"> ■ PV alarm Unit: °C/°F Setting range: Minimum value to maximum value of measured input range ■ Deviation alarm Unit: °C/°F Setting range: —100 to 100% of measured input range span | Max. value of measured input range (PV alarm) | | P.4-12 P.4-16 P.4-17 |
| A2 | Alarm 2 setpoint | <ul style="list-style-type: none"> ■ Heater disconnection alarm Unit: A (ampere) Setting range: OFF(0), 1 to 80 (can be set for the alarm 1 setpoint only) | Min. value of measured input range (PV alarm) | | |
| HC | Heater disconnection current measured value | HC is not a parameter to be set. The current value (0 to 80) of heater disconnection detector is displayed. Unit: A (ampere) Settings: When the display value is — — —, the heater current is not being measured. | | | |
| CTL | Control mode | ONF(0): On/off control PID(1): PID control SLF(2): Dynamic auto tune control (cannot be set for heating/cooling control) | SLF(2): standard type; PID(1): heating/cooling type | | P.4-5 P.6-1 P.6-6 |
| AT | Auto-tuning | OFF(0): Stop auto-tuning(AT) ON(1): Start auto-tuning(AT) | OFF(0) | | P.6-7 |
| P | Proportional band | 1°C/°F to the temperature that corresponds to 100% of the measured input range span | 5% of measured input range span | | P.6-2 |
| I | Integral time | 1 to 999 seconds; OFF(0): no integral action | 240 seconds | | P.6-4 |
| D | Derivative time | 1 to 999 seconds; OFF(0): no derivative action | 60 seconds | | P.6-5 |
| MR | Manual reset | -19.9 to 99.9 % : Standard type -100 to 100 % : Heating/cooling type | 50.0% : Standard type; 0.0% : Heating/cooling type | | P.6-4 |
| COL | Cooling-side gain | 0.01 to 9.99 times | 1.00 time | | P.5-8 |
| DB | Dead band | <ul style="list-style-type: none"> ■ PID control Unit: °C/°F Setting range: —(proportional band setting) to +(proportional band setting) ■ On/off control Unit: °C/°F Setting range: —50 to +50% of measured input range span | 0% of measured input range span | | P.5-8 |
| HYS | Hysteresis for on/off control | 0°C/°F to the temperature that corresponds to 100% of the measured input range span | 0.5% of measured input range span | | P.6-1 |
| CT | Control output cycle time | 1 to 240 seconds | 30 seconds | | P.4-8 P.6-8 |
| CTC | Cooling-side control output cycle time | 1 to 240 seconds | 30 seconds | | P.6-8 |
| FL | PV input filter | OFF(0), 1 to 120 seconds | OFF(0) | | P.5-2 |
| BS | PV input bias | —100 to 100% of measured input range span | 0% of measured input range span | | P.5-1 |
| LOC | Key lock | 0: No key lock 1: Prevents operations from being changed except for the changing of SP in the operating display 2: Prevents all parameter changing operations —1: Set -1 to enter the setup parameter setting display. But if LOC=1 or 2 is already set, the parameter value can not be changed by setting LOC=-1 only. To change the parameter value, set LOC=0 at first (for disabling keylock), then set LOC=-1 once again. | 0 | | P.5-7 |

 **NOTE**

Changing certain setup parameter may automatically initialize the operating parameters. Therefore, after you change the setup parameters, always check the operating parameter settings to find out if appropriate values have been set for them. If the operating parameters have been initialized, set them to their appropriate values.

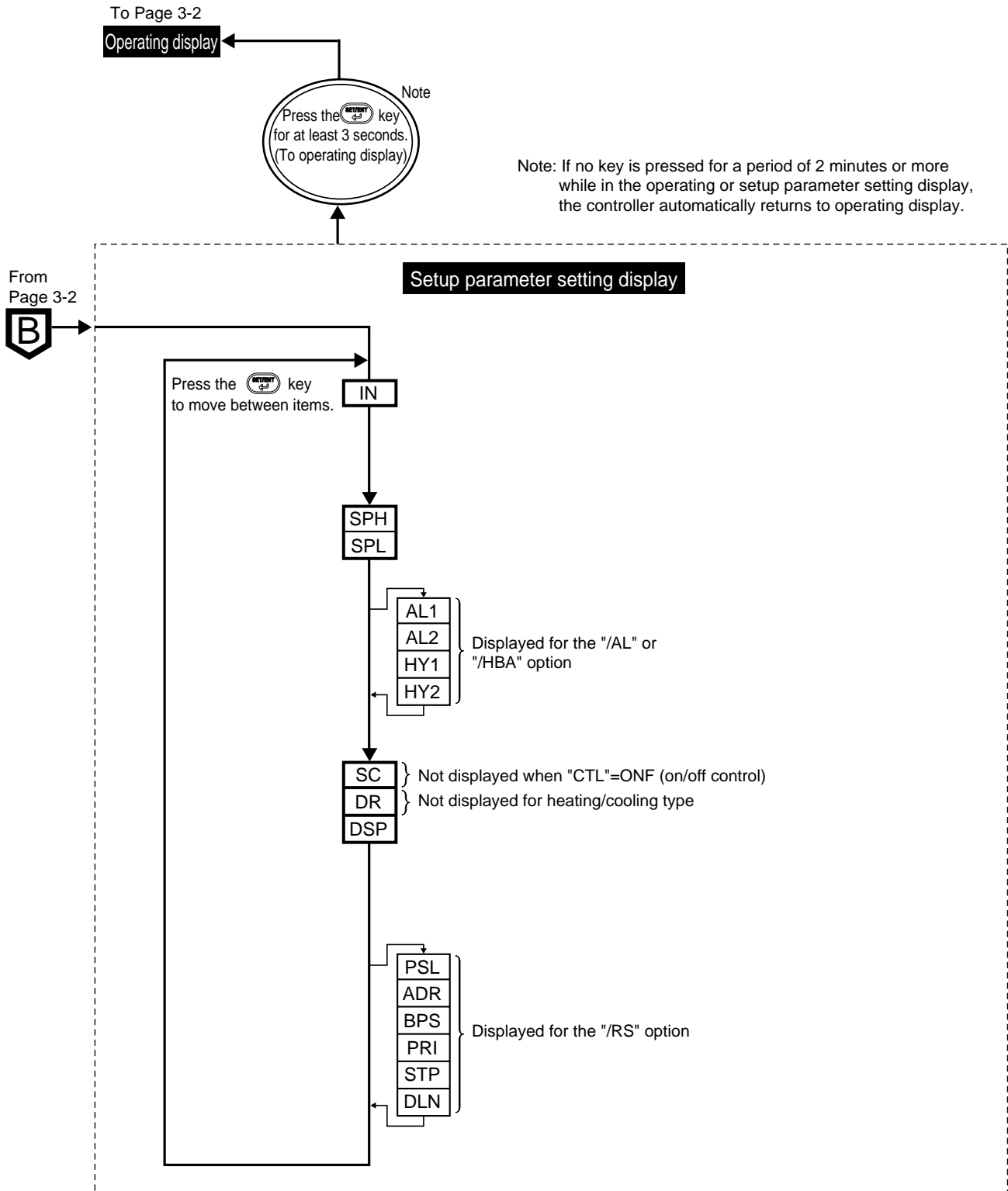

Numbers in () are the parameter setpoints that apply when the communication function is used.
Ex. OFF(0), ON(1)

(3) Setup Parameters: Parameters rarely changed in normal use after once having been set.

| Code | Name | Setting range and unit | Default | User setting | Reference page |
|---------------------------|--|---|--|--------------|----------------------------|
| IN <i>In</i> | Measured input type | 1 to 7, 12, 13, 15 to 19, 31 to 37, 42, 43, 45 to 48 (See the measured input range code list.) OFF(0): No input (If no input type is specified at the time of ordering, you must set the input type.) | OFF(0), or the input range code specified with | | P.4-1 P.5-1 |
| SPH <i>SPH</i> | Maximum value of target setpoint range | (SPL+1°C) to the maximum value of measured input range; Unit: °C/°F | Maximum value of measured input range | | P.5-2 |
| SPL <i>SPL</i> | Minimum value of target setpoint range | Minimum value of measured input range to (SPH—1°C) Unit: °C/°F | Minimum value of measured input range | | |
| AL1 <i>AL1</i> | Alarm 1 type | OFF(0), 1 to 22 (See the alarm function list.) 25 (for the heater disconnection alarm /HBA option only) | 1 (PV high limit alarm) | | P.4-12 P.4-16 P.4-17 |
| AL2 <i>AL2</i> | Alarm 2 type | OFF(0), 1 to 22 (See the alarm function list.) | 2 (PV low limit alarm) | | |
| HY1 <i>HY1</i> | Alarm 1 hysteresis | 0 to 100% of measured input range span Unit: °C/°F | 0.5% of measured input range span | | |
| HY2 <i>HY2</i> | Alarm 2 hysteresis | | | | |
| SC <i>SC</i> | SUPER function | ON(1): Uses the SUPER function OFF(0): Does not use SUPER function Note: Not displayed when on/off control | OFF(0) | | P.6-10 |
| DR <i>dr</i> | Direct/reverse action | 0: Reverse action 1: Direct action Note: Not displayed for heating/cooling type | 0 | | P.4-6 |
| DSP <i>dSP</i> | Priority of PV/SP display | 0: Displays PV 1: Displays target setpoint (SP) | 0 | | P. |
| PSL <i>PSL</i> | Protocol selection | 0: PC-link communication 1: PC-link communication with sum check 2: Ladder communication 3: MODBUS in ASCII mode 4: MODBUS in RTU mode | 0 | | P.5-9 |
| ADR <i>Adr</i> | Controller address | 1 to 99 However, the number of controllers that can be connected per host device is 31 at the maximum. | 1 | | |
| BPS <i>bPS</i> | Baud rate | 2.4(0): 2400 bps 4.8(1): 4800 bps 9.6(2): 9600 bps | 9.6(2) | | |
| PRI <i>P_r1</i> | Parity | NON(0): Disabled EVN(1): Even parity ODD(2): Odd parity | EVN(1) | | |
| STP <i>StP</i> | Stop bit | 1 or 2 bits | 1 bit | | |
| DLN <i>dLn</i> | Data length | 7 or 8 bits • 8 bits when ladder, MODBUS (RTU) • 7 bits when MODBUS (ASCII) | 8 bits | | |

3.3 UT150/UT152/UT155 Names and Functions of Each Part (Principles of Key Operation)

SP2 lamp (green)

Lit when SP2 is being used for control operation.

Alarm 1 (AL1), Alarm 2 (AL2) lamps (red)

AL1: Lit when the alarm 1 is activated.
AL2: Lit when the alarm 2 is activated.

Output (OUT) display lamps (Left: orange; right: green)

Lit while control output is being output.
Flashes according to the control output value during time-proportional output or current output. (Flashes slowly when current control output value is small; flashes fast when it is large.)

- The left lamp is lit in orange during control output of standard type.
- In heating/cooling control, the left lamp lights up in orange when the heating-side output is active; while the right lamp lights up in green when the cooling-side output is active.

SET / ENT key (data registering key)

- Registers the data value changed using the data change keys.
- Switches between operating displays or parameter setting displays sequentially.
- Pressing the key for 3 seconds or more in the operating display retrieves the operating parameter setting display. You can transfer to the setup parameter setting display form the operating parameter setting display.
- Pressing the key for 3 seconds or more in either an operating or setup parameter setting display transfers back to operating display.



PV display (red)

Indicates PV (measured value) and character information such as parameter codes and error codes.

SP display (green)

Indicates SP (target setpoint) and parameter values.

Data change keys

- Change SP and the parameter values.
- Pressing the  key decreases the data value and pressing the  key increases it. Holding down the key will gradually increase the speed of the change.

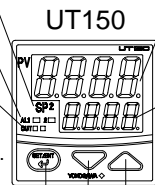

SP2 lamp (green)

Lit when SP2 is being used for control operation.

Alarm 1 (AL1), Alarm 2 (AL2) lamps (red)

AL1: Lit when the alarm 1 is activated.
AL2: Lit when the alarm 2 is activated.

Output (OUT) display lamps (Upper: orange; lower: green)

Lit while control output is being output.
Flashes according to the control output value during time-proportional output or current output. (Flashes slowly when current control output value is small; flashes fast when it is large.)

- The upper lamp is lit in orange during control output of standard type.
- In heating/cooling control, the upper lamp lights up in orange when the heating-side output is active; while the lower lamp lights up in green when the cooling-side output is active.

SET / ENT key (data registering key)

- Registers the data value changed using the data change keys.
- Switches between operating displays or parameter setting displays sequentially.
- Pressing the key for 3 seconds or more in the operating display retrieves the operating parameter setting display. You can transfer to the setup parameter setting display form the operating parametersetting display.
- Pressing the key for 3 seconds or more in either an operating or setup parameter setting display transfers back to operating display.



PV display (red)

Indicates PV (measured value) and character information such as parameter codes and error codes.

SP display (green)

Indicates SP (target setpoint) and parameter values.

Data change keys

- Change SP and the parameter values.
- Pressing the  key decreases the data value and pressing the  key increases it. Holding down the key will gradually increase the speed of the change.

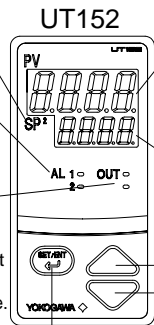

SP2 lamp (green)

Lit when SP2 is being used for control operation.

Alarm 1 (AL1), Alarm 2 (AL2) lamps (red)

AL1: Lit when the alarm 1 is activated.
AL2: Lit when the alarm 2 is activated.

**Output (OUT) display lamps
(Upper: orange; lower: green)**

Lit while control output is being output.
Flashes according to the control output value during time-proportional output or current output. (Flashes slowly when current control output value is small; flashes fast when it is large.)

- The upper lamp is lit in orange during control output of standard type.
- In heating/cooling control, the upper lamp lights up in orange when the heating-side output is active; while the lower lamp lights up in green when the cooling-side output is active.

SET / ENT key (data registering key)

- Registers the data value changed using the data change keys.
- Switches between operating displays or parameter setting displays sequentially.
- Pressing the key for 3 seconds or more in the operating display retrieves the operating parameter setting display. You can transfer to the setup parameter setting display from the operating parameter setting display.
- Pressing the key for 3 seconds or more in either an operating or setup parameter setting display transfers back to operating display.

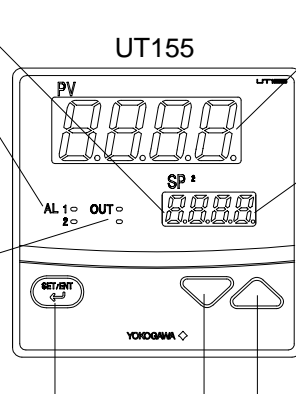



PV display (red)

Indicates PV (measured value) and character information such as parameter codes and error codes.

SP display (green)

Indicates SP (target setpoint) and parameter values.

Data change keys

- Change SP and the parameter values.
- Pressing the  key decreases the data value and pressing the  key increases it. Holding down the key will gradually increase the speed of the change.

3.4 UT150/UT152/UT155 Parameter Flowchart and Description

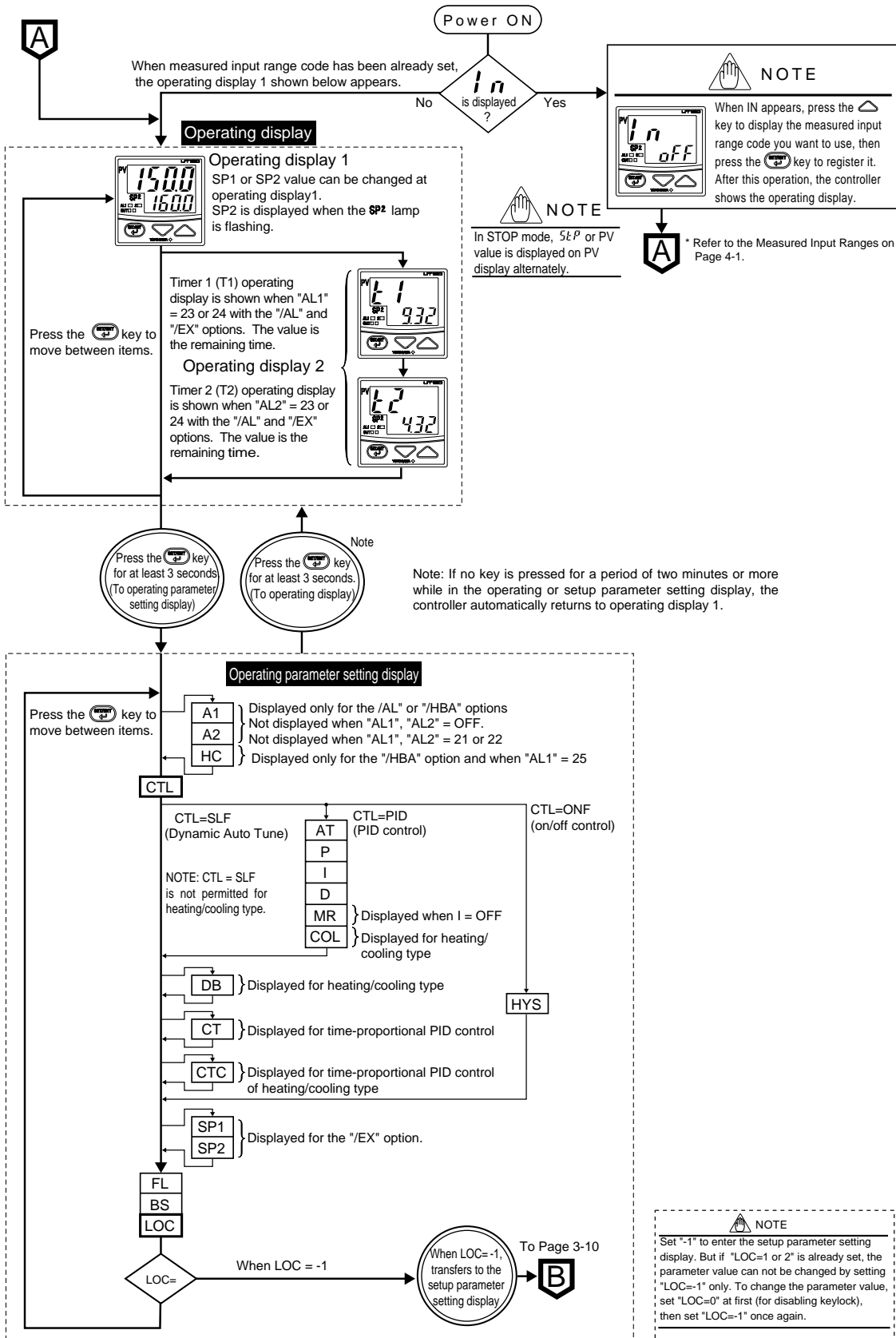

(1) Target Setpoint (SP) and Timer Settings 1 and 2

| Code | Name | Setting range and unit | Default | User setting | Reference page |
|--------------------|-----------------|---|---------|--------------|----------------|
| (SP value display) | Target setpoint | Minimum value (SPL) to maximum value (SPH) of target setpoint range | SPL | | P.4-10 |
| T1 <i>tl</i> | Timer setting 1 | 0.0 to 99.59 Unit: minutes and seconds or hours and minutes Set the timer time unit using the parameter TTU. For example, 15.25 sets 15 minutes and 25 seconds when the unit is minutes and seconds.(T1 is for AL1, and T2 is for AL2) | 0.00 | | P.5-6 |
| T2 <i>tl</i> | Timer setting 2 | | 0.00 | | |

Numbers in () are the parameter setpoints that apply when the communication function is used.
Ex. OFF(0), ON(1)

(2) Operating Parameters: Parameters changed rather frequently during operation.

| Code | Name | Setting range and unit | Default | User setting | Reference page |
|----------------|---|--|---|--------------|----------------------------|
| A1 <i>A1</i> | Alarm 1 setpoint | <ul style="list-style-type: none"> ■ PV alarm Unit: °C/°F Setting range: minimum value to maximum value of measured input range (scale) ■ Deviation alarm Unit: °C/°F Setting range: —100 to 100% of measured input range (scale) span ■ Heater disconnection alarm Unit: A (ampere) Setting range: OFF(0), 1 to 80 (can be set for the alarm 1 setpoint only) | Max. value of measured input range (scale) (PV alarm) | | P.4-12 P.4-16 P.4-17 |
| A2 <i>A2</i> | Alarm 2 setpoint | | Min. value of measured input range (scale) (PV alarm) | | |
| HC <i>HC</i> | Heater disconnection current measured value | HC is not a parameter to be set. The current value (0 to 80) of heater disconnection detector is displayed. Unit: A (ampere) Settings: When the display value is — — — —, the heater current is not being measured. | | | |
| CTL <i>CTL</i> | Control mode | ONF(0): On/off control PID(1): PID control SLF(2): Dynamic auto tune control (cannot be set for heating/cooling control) | SLF(2) :for standard type; PID(1) : for heating/cooling type | | P.4-5 P.6-1 P.6-6 |
| AT <i>AT</i> | Auto-tuning | OFF(0): Stop auto-tuning ON(1): Start auto-tuning | OFF(0) | | P.6-7 |
| P <i>P</i> | Proportional band | 1°C/°F to the temperature that corresponds to 100% of the measured input range (scale) span | 5% of measured input range (scale) | | P.6-2 |
| I <i>I</i> | Integral time | 1 to 3600 seconds; OFF(0): no integral action | 240 seconds | | P.6-4 |
| D <i>d</i> | Derivative time | 1 to 3600 seconds; OFF(0): no derivative action | 60 seconds | | P.6-5 |
| MR <i>mr</i> | Manual reset | —100 to 100% | 50.0% for standard type; 0.0% for heating/cooling type | | P.6-4 |
| COL <i>COL</i> | Cooling-side gain | 0.01 to 9.99 times | 1.00 times | | P.5-8 |
| DB <i>db</i> | Dead band | <ul style="list-style-type: none"> ■ PID control Unit: °C/°F Setting range: —(proportional band setting) to +(proportional band setting) ■ On/off control Unit: °C/°F Setting range: —50 to +50% of measured input range (scale)span | 0% of measured input range (scale) span | | P.5-8 |
| HYS <i>HYS</i> | Hysteresis for on/off control | 0°C/°F to the temperature that corresponds to 100% of the measured input range (scale) span | 0.5% of measured input range (scale) span | | P.6-1 |
| CT <i>ct</i> | Control output cycle time | 1 to 240 seconds | 30 seconds | | P.4-8 P.6-8 |
| CTC <i>ctc</i> | Cooling-side control output cycle time | 1 to 240 seconds | 30 seconds | | P.6-8 |
| SP1 <i>SP1</i> | Target setpoint 1 | Minimum value (SPL) to maximum value (SPH) of target setpoint range Unit: °C/°F | SPL | | P.4-10 |
| SP2 <i>SP2</i> | Target setpoint 2 | There are also optional engineering units for voltage input. | SPL | | P.5-4 |
| FL <i>FL</i> | PV input filter | OFF(0), 1 to 120 seconds | OFF(0) | | P.5-2 |
| BS <i>bs</i> | PV input bias | —100 to 100% of measured input range (scale) span | 0% of measured input range (scale) span | | P.5-1 |
| LOC <i>LoC</i> | Key lock | 0: No key lock 1: Prevents operations from being changed except for the changing of SP in the operating display 2: Prevents all parameter changing operations —1: Set -1 to enter the setup parameter setting display. But if LOC=1 or 2 is already set, the parameter value can not be changed by setting LOC=-1 only. To change the parameter value, set LOC=0 at first (for disabling keylock), then set LOC=-1 once again. | 0 | | P.5-7 |



NOTE

Changing certain setup parameter may automatically initialize the operating parameters. Therefore, after you change the setup parameters, always check the operating parameter settings to find out if appropriate values have been set for them. If the operating parameters have been initialized, set them to their appropriate values.

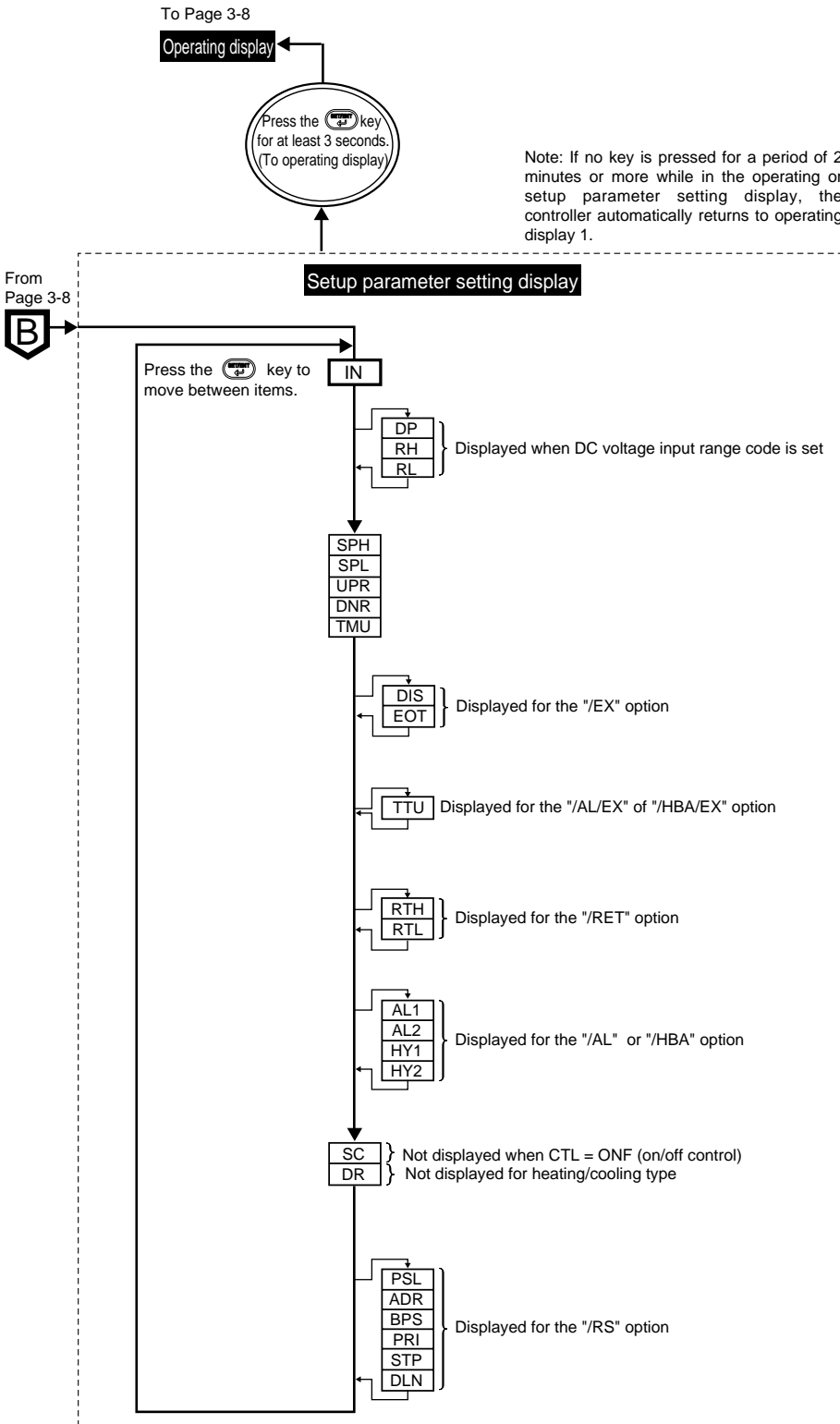

(3) Setup Parameters: Parameters rarely changed in normal use after once having been set.

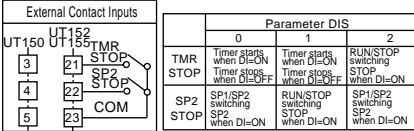
| Code | Name | Setting range and unit | Default | User setting | Reference page |
|------|------------|--|--|--------------|-------------------------------------|
| IN | <i>ln</i> | Measured input type 1 to 23, 31 to 48 (See input range code list.) OFF(0): No input (If no input type is specified at the time of ordering, you must set the input) | OFF(0), or the input range code specified with order | | P.4-1 P.5-1 |
| DP | <i>dP</i> | Decimal point position of measured input 0: No decimal place (nnn) (Displayed at voltage input) 1: One decimal place (nn.n) 2: Two decimal places (nn.nn) 3: Three decimal places (n.nnn) | 1 | | |
| RH | <i>rH</i> | Maximum value of measured input scale (RL + 1) to 9999 (Displayed at voltage input) | 100.0 | | |
| RL | <i>rL</i> | Minimum value of measured input scale —1999 to (RH —1) (Displayed at voltage input) | 0.0 | | |
| SPH | <i>SPH</i> | Maximum value of target setpoint range (SPL+1°C) to the maximum value of measured input range (scale) ; Unit: °C/°F | Maximum value of measured input range (scale) | | P.5-2 |
| SPL | <i>SPL</i> | Minimum value of target setpoint range Minimum value of measured input (scale) range to (SPH —1°C) Unit: °C/°F | Minimum value of measured input range (scale) | | |
| UPR | <i>UPr</i> | Setpoint ramp-up-rate OFF(0) or a value from the minimum to the maximum value of t measured input range (scale) Unit: °C/min or °C/hour, °F/min or °F/hour Set the ramp-rate time unit using parameter TMU. | OFF(0) | | P.5-3 |
| DNR | <i>dnr</i> | Setpoint ramp-down-rate | OFF(0) | | |
| TMU | <i>tAU</i> | Setpoint ramp-rate time unit 0 : °C or °F / hour 1 : °C or °F / min | 1 | | |
| DIS | <i>diS</i> | DI-function selection  | 0 | | P.5-4 P.5-5 P.5-6 |
| EOT | <i>Eot</i> | Output in STOP mode In STOP mode by contact input, fixed control output can be generated. 0 : 0%, 1 : 100% | 0 | | P.5-5 |
| TTU | <i>tTU</i> | Timer time unit 0 : hour, minute 1 : minute, second | 1 | | P.5-6 |
| RTH | <i>rTH</i> | Maximum value of retransmission output Temperature input : Within measured input range Voltage input : RTL+1digit to max. value of measured input scale (RH) | Maximum value of measured input range (scale) | | P.5-4 |
| RTL | <i>rTL</i> | Minimum value of retransmission output Min. value of measured input scale (RL) to RTH-1digit However, RTL<RTH | Minimum value of measured input range (scale) | | |
| AL1 | <i>AL1</i> | Alarm 1 type OFF(0) or a value from 1 to 22 (see the table of alarm function list), and either 23 or 24 (if the timer function [EX option] is included), and 25 (if the heater disconnection function [HBA option] is included) | 1 (PV high limit alarm) | | P.4-12 P.4-16 P.4-17 P.5-6 |
| AL2 | <i>AL2</i> | Alarm 2 type OFF(0) or a value from 1 to 22 (see the table of alarm function list), and either 23 or 24 (if the timer function [EX option]) is included) | 2 (PV low limit alarm) | | |
| HY1 | <i>HY1</i> | Alarm 1 hysteresis 0 to 100% of measured input range (scale) span Unit: °C/°F | 0.5% of measured input range (scale) span | | |
| HY2 | <i>HY2</i> | Alarm 2 hysteresis | | | |
| SC | <i>SC</i> | SUPER function ON(1): Uses the SUPER function OFF(0): Does not use SUPER function Note: Not displayed when on/off control | OFF(0) | | P.6-10 |
| DR | <i>dr</i> | Direct/reverse action 0: Reverse action 1: Direct action Note: Not displayed for heating/cooling type | 0 | | P.4-6 |
| PSL | <i>PSL</i> | Protocol selection 0: PC-link communication 1: PC-link communication with sum check 2: Ladder communication 3: MODBUS in ASCII mode 4: MODBUS in RTU mode | 0 | | P.5-9 |
| ADR | <i>Adr</i> | Controller address 1 to 99 However, the number of controllers that can be connected per host device is 31 at the maximum. | 1 | | |
| BPS | <i>bPS</i> | Baud rate 2.4(0): 2400 bps 4.8(1): 4800 bps 9.6(2): 9600 bps | 9.6(2) | | |
| PRI | <i>Pr1</i> | Parity NON(0): Disabled EVN(1): Even parity ODD(2): Odd parity | EVN(1) | | |
| STP | <i>StP</i> | Stop bit 1 or 2 bits | 1 bit | | |
| DLN | <i>dLn</i> | Data length 7 or 8 bits • 8 bits when ladder, MODBUS (RTU) • 7 bits when MODBUS (ASCII) | 8 bits | | |

4. BASIC OPERATIONS

This chapter describes an operating procedure using temperature controllers UT130 and UT150 of standard type with the alarm option as an example. Regarding the operating procedure for the heating/cooling type controller or for the controller with the options other than the alarm, confirm whether the some parameters appear or not referring to the parameter flowchart in “3. NAMES AND FUNCTIONS OF EACH PART / PARAMETERS.” The operating procedure for UT152/UT155 is the same as that for UT150.

4.1 Setting Measured Input Type and Scale (Setting First)

The operating procedure to set first after purchasing a controller is described in this section. The procedure is for the parameter “IN” (measured input type) = OFF.

UT130 Measured Input Ranges

| Input type | Range (°C) | Range code (°C) | Range (°F) | Range code (°F) | |
|--------------|-----------------|-----------------|---------------|-----------------|----|
| Thermocouple | Unspecified | OFF | | | |
| | K | —199 to 999°C | 1 | —199 to 999°F | 31 |
| | | 0 to 600°C | 2 | 32 to 999°F | 32 |
| | | 0 to 400°C | 3 | 32 to 750°F | 33 |
| | | —199 to 200°C | 4 | —199 to 400°F | 34 |
| | J | —199 to 999°C | 5 | —199 to 999°F | 35 |
| T | —199 to 400°C | 6 | —199 to 750°F | 36 | |
| E | —199 to 999°C | 7 | —199 to 999°F | 37 | |
| L | —199 to 900°C | 12 | —199 to 999°F | 42 | |
| U | —199 to 400°C | 13 | —199 to 750°F | 43 | |
| RTD | —199 to 850°C | 15 | —199 to 999°F | 45 | |
| | 0 to 400°C | 16 | 32 to 750°F | 46 | |
| | —199 to 200°C | 17 | —199 to 400°F | 47 | |
| | —19.9 to 99.9°C | 18 | —199 to 999°F | 48 | |
| JPt100 | —199 to 500°C | 19 | | | |

UT150/UT152/UT155 Measured Input Ranges

| Input type | Range (°C) | Range code (°C) | Range (°F) | Range code (°F) | |
|--------------|-------------|-------------------|---------------|-------------------|----|
| Thermocouple | Unspecified | OFF | | | |
| | K | —270 to 1370°C | 1 | —300 to 2500°F | 31 |
| | | 0.0 to 600.0°C | 2 | 32.0 to 999.9°F | 32 |
| | | 0.0 to 400.0°C | 3 | 32.0 to 750.0°F | 33 |
| | | —199.9 to 200.0°C | 4 | —300 to 400°F | 34 |
| | J | —199.9 to 999.9°C | 5 | —300 to 2100°F | 35 |
| | T | —199.9 to 400.0°C | 6 | —300 to 750°F | 36 |
| | E | —199.9 to 999.9°C | 7 | —300 to 1800°F | 37 |
| | R | 0 to 1700°C | 8 | 32 to 3100°F | 38 |
| | S | 0 to 1700°C | 9 | 32 to 3100°F | 39 |
| | B | 0 to 1800°C | 10 | 32 to 3200°F | 40 |
| | N | —200 to 1300°C | 11 | —300 to 2400°F | 41 |
| | L | —199.9 to 900.0°C | 12 | —300 to 1600°F | 42 |
| | U | —199.9 to 400.0°C | 13 | —300 to 750°F | 43 |
| RTD | Platine1 2 | 0 to 1390°C | 32 to 2500°F | 44 | |
| | Pt100 | —199.9 to 850.0°C | 15 | —199.9 to 999.9°F | 45 |
| | | 0.0 to 400.0°C | 16 | 32.0 to 750.0°F | 46 |
| | | —199.9 to 200.0°C | 17 | —300 to 400°F | 47 |
| | | —19.9 to 99.9°C | 18 | —199.9 to 999.9°F | 48 |
| | JPt100 | —199.9 to 500.0°C | 19 | | |
| DC voltage | 0 to 100mV | 0.0 to 100.0 | | 20 | |
| | 0 to 5V | 0.000 to 5.000 | User-scalable | 21 | |
| | 1 to 5V | 1.000 to 5.000 | | 22 | |
| | 0 to 10V | 0.00 to 10.00 | | 23 | |

The following operating procedure describes an example of setting “K-type thermocouple” (0.0 to 400.0°C) for the measured input type. For voltage input of UT150/UT152/UT155, the display scale can be set using the parameters “DP” (decimal point position of measured input), “RH” (maximum value of measured input scale) and “RL” (minimum value of measured input scale).

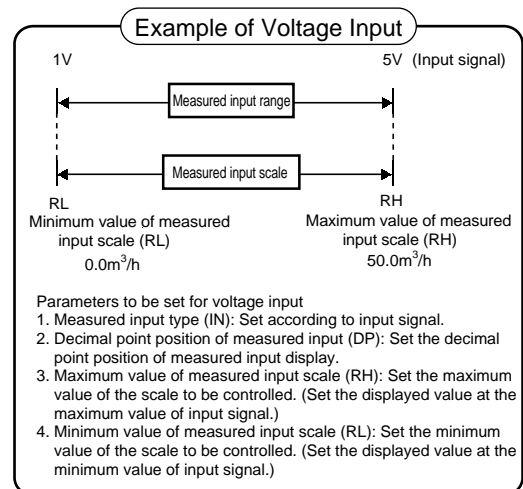
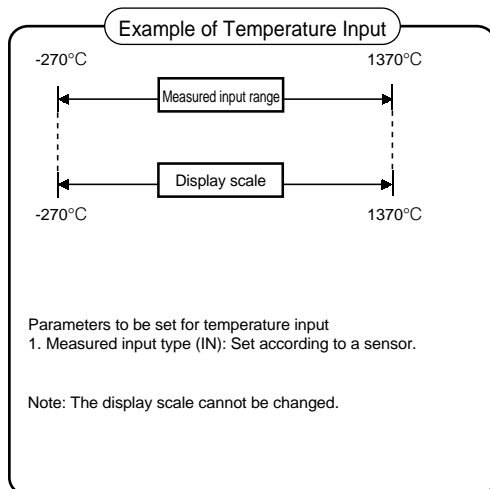

● Setting a Type of Temperature Input

The following operating procedure describes an example of setting "K-type thermocouple" (0.0 to 400.0°C) for the measured input type.

<Operating Procedure>

Step 1:
The parameter "IN" (measured input type) appears at power on.

UT130
Display example

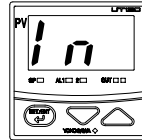

UT150/UT152/UT155
Display example

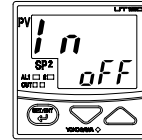

Step 2 (for UT130 only):
Press the or key once to display the setpoint.

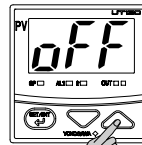

Step 3:
Press the or key to set the required setpoint for the measured input type. The measured input type is set using a range code. (See Page 4-1)
The period flashes while the value is being changed. In this example, "K-type thermocouple" (0.0 to 400.0°C) is set for the measured input type.

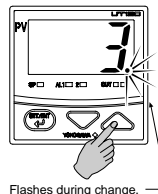

Flashes during change.

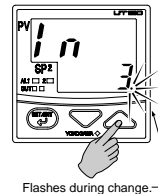

Flashes during change.

Step 4:
Press the key once to register the setpoint. The operating display appears automatically.

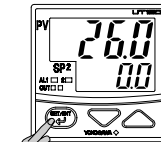
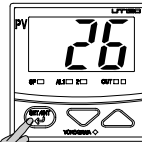

● Setting a Voltage Input Type and Display Scale (for UT150/UT152/UT155 only)

The following operating procedure describes an example of setting "1 to 5V DC voltage input signals" for the measured input type, and "0.0 to 500.0" for the display scale.

<Operating Procedure>

Step 1:

The parameter "IN" (measured input type) appears at power on.

Step 2:

Press the Δ or ∇ key to set the required setpoint for the measured input type. The measured input type is set using a range code. (See Page 4-1)
The period flashes while the value is being changed. In this example, "1 to 5V DC" (setpoint: 22) is set for the measured input type.

Step 3:

Press the SP key once to register the setpoint. The operating display appears automatically.

The Step 4 onwards describes the procedure to set a display scale. The display scale is changed from "0.0 to 100.0" (factory-set default) to "0.0 to 500.0".

Step 4:

Press the SP key for 3 seconds or more to display the parameter "A1".
The parameter "A1" appears only for the controller with the "/AL" or "/HBA" option.
The parameter "CTL" appears for the controller without the "/AL" or "/HBA" option.

Step 5:

Press the SP key several times to display the parameter "LOC."

NOTE
Set "-1" to enter the setup parameter setting display. But if "LOC" = 1 or 2 is already set, the parameter value can not be changed by setting "LOC" = -1 only. To change the parameter value, set "LOC" = 0 at first (for disabling key lock), then set "LOC" = -1 once again

Step 6:

Press the Δ or ∇ key to display "-1."

UT150/UT152/UT155 Display example

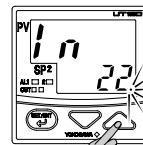
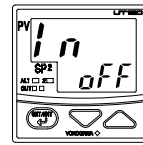

Flashes during change.

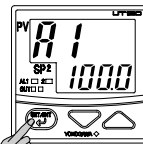
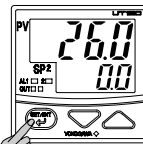

Flashes during change.





To the next page

Step 7:

Press the  key once to display the parameter "IN" (measured input type). The value set in steps 1 to 3 appears.

Step 8:

Press the  key once. In this example, the parameter "DP" (decimal point position) is set to "1" (one decimal place).

When DP = 1 (one decimal place), 

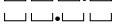
When DP = 2 (two decimal places), 

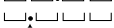

When DP = 3 (three decimal places), 

Decimal point position

Step 9:

Press the  key once to display the parameter "RH" (maximum value of measured input scale). The factory-set default "100.0" appears on SP display.

Step 10:

Press the  or  key to display the setpoint "500.0". The period flashes while the value is being changed.

Step 11:

Press the  key once to register the setpoint. The period is lit when the registration is completed.

Step 12:

Press the  key once to display the parameter "RL" (minimum value of measured input scale). The factory-set default "0.0" is displayed on SP display. In this example, "0.0" is set for the minimum value of measured input scale.

Step 13:

Press the  key for 3 seconds or more to return to the operating display.

From the previous page

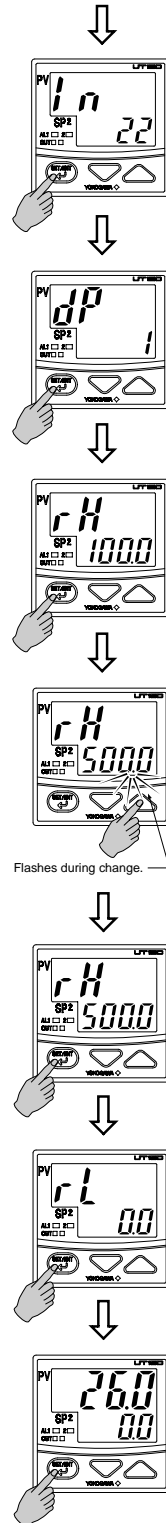

4.2 Setting Control Action

4.2.1 Selecting a Control Mode (Dynamic Auto Tune Control / PID Control / ON-OFF Control)

The following operating procedure describes an example of changing Dynamic Auto Tune control to PID control. When PID control is selected, PID should be obtained by Auto tuning or PID should be set manually. Refer to "6. DESCRIPTION OF EACH FUNCTION" (Page 6-1) for the function of control mode.

<Operating Procedure>

Step 1:
Bring the operating display into view.

UT130
Display example

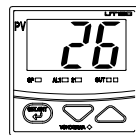

UT150/UT152/UT155
Display example

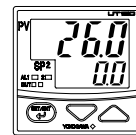

Step 2:
Press the key for 3 seconds or more to display the parameter "A1".
The parameter "A1" appears only for the controller with the "/AL" or "/HBA" option.
The parameter "CTL" appears for the controller without the "/AL" or "/HBA" option

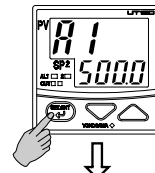
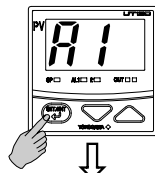

Step 3:
Press the key several times to display the parameter "CTL"(control mode).

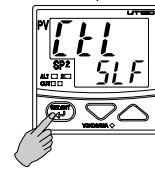
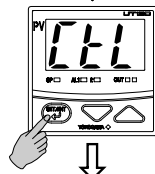

Step 4 (for UT130 only):
Press the or key once to display the setpoint.



Step 5:
Press the or key to select a control action. The modes and setting ranges of control action are as follows:
(ON/OFF control: ONF
PID control: PID
Dynamic Auto Tune control: SLF)
The period flashes while the value is being changed.
In this example, the control mode is changed from Dynamic Auto Tune control (setpoint: SLF) to PID control (setpoint: PID).

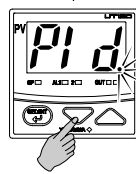

Flashes during change.



Flashes during change.

Step 6:
Press the key once to register the setpoint.

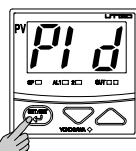

The period is OFF.

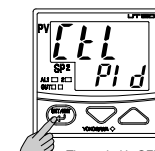

The period is OFF.

Step 7:
Press the key for 3 seconds or more to return to the operating display.

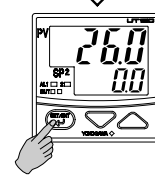
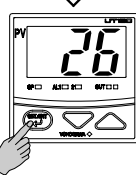

4.2.2 Switching Direct / Reverse Action

Direct and reverse action define the direction in which output increase or decrease, according to whether deviation of target setpoint (SP) and measured input (PV) is positive or negative. Reverse action is used for temperature control in a heating control, and direct action for cooling control. Factory set to Reverse action.

Direct/reverse switching is unavailable in heating/cooling control.

| | Reverse Action (DR = 0) | | Direct Action (DR = 1) | |
|---------------------------------------|--|------------------------------|--|------------------------------|
| Condition | PV > SP | PV < SP | PV > SP | PV < SP |
| ON/OFF output status | OFF | ON | ON | OFF |
| Current output | Decreases. | Increases. | Increases. | Decreases. |
| Time proportional output | The ON-state time decreases. | The ON-state time increases. | The ON-state time increases. | The ON-state time decreases. |
| Direction of change in control output | Reverse Action | | Direct Action | |
| | Minimum (PV value is smaller) Maximum (PV value is greater) | | Minimum (PV value is smaller) Maximum (PV value is greater) | |

<Operating Procedure>

Step 1:
Bring the operating display into view.

UT130
Display example

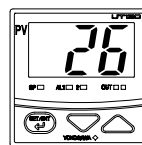

UT150/UT152/UT155
Display example

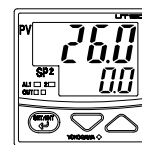

Step 2:
Press the key for 3 seconds or more to display the parameter "A1".
The parameter "A1" appears only for the controller with the "/AL" or "/HBA" option.
The parameter "CTL" appears for the controller without the "/AL" or "/HBA" option

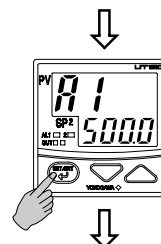
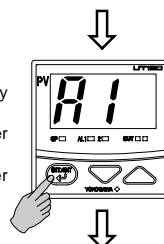

Step 3:
Press the key several times to display the parameter "LOC".

NOTE
Set "-1" to enter the setup parameter setting display. But if "LOC" = 1 or 2 is already set, the parameter value can not be changed by setting "LOC" = -1 only. To change the parameter value, set "LOC" = 0 at first (for disabling key lock), then set "LOC" = -1 once again

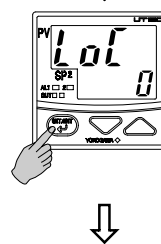
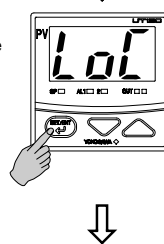

To the next page

To the next page

Step 4 (for UT130 only):
Press the or key once to display the setpoint.

From the previous page

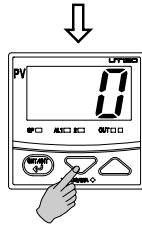

From the previous page



Step 5:
Press the key to display "-1".

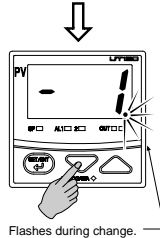

Flashes during change.

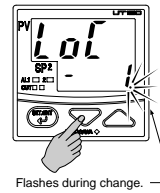

Flashes during change.

Step 6:
Press the key once.

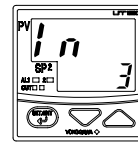
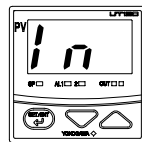

Step 7:
Press the key several times to display the parameter "DR" (direct/reverse switching).

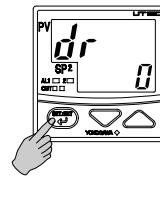
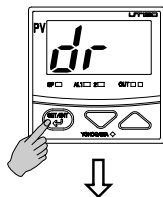

Step 8 (for UT130 only):
Press the or key once to display the setpoint.

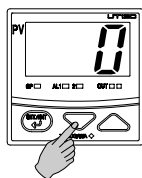

Step 9:
Press the or key to set the direct action (setpoint: 1).

Reverse action: DR = 0
Direct action: DR = 1

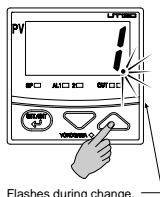

Flashes during change.

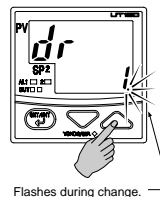

Flashes during change.

Step 10:
Press the key once to register the setpoint.

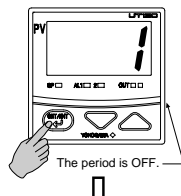

The period is OFF.

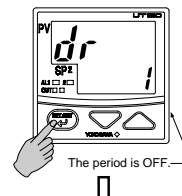

The period is OFF.

Step 11:
Press the key for 3 seconds or more to return to the operating display.

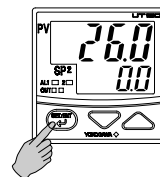
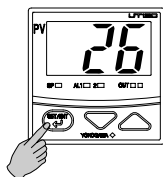

4.2.3 Setting Cycle Time (Control Output Renewal Period)

The cycle time can be set when the control output type is time-proportional relay output or voltage pulse output. The parameter to set a cycle time does not appear in ON/OFF control (CTL = ONF) or in Dynamic Auto Tune control (CTL = SLF). Refer to "6.6.2 Cycle Time" on Page 6-8 for the functional description of cycle time.

The following operating procedure describes an example of changing the cycle time form 30 seconds to 40 seconds.

<Operating Procedure>

Step 1:
Bring the operating display into view.

UT130
Display example

UT150/UT152/UT155
Display example

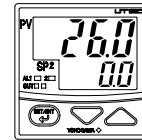
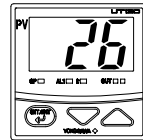

Step 2:
Press the key for 3 seconds or more to display the parameter "A1".
The parameter "A1" appears only for the controller with the "/AL" or "/HBA" option.
The parameter "CTL" appears for the controller without the "/AL" or "/HBA" option

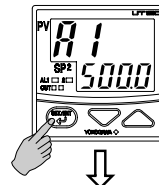
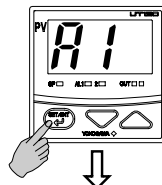

Step 3:
Press the key several times to display the parameter "CT".

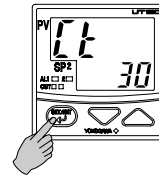
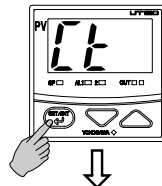

Step 4 (for UT130 only):
Press the or key once to display the setpoint.

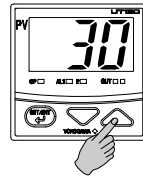

Step 5:
Press the or key to set the cycle time.
The period flashes while the value is being changed.
In this example, the cycle time is changed to 40

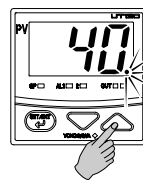

Flashes during change.

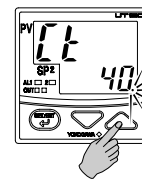

Flashes during change.

Step 6:
Press the key once to register the setpoint.

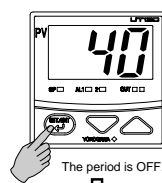

The period is OFF.

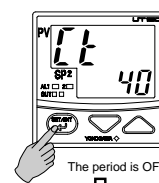

The period is OFF.

Step 7:
Press the key for 3 seconds or more to return to the operating display.

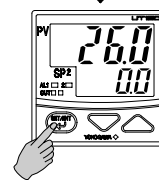
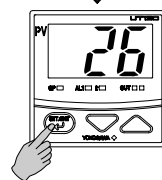

4.3 Setting Target Setpoint (SP)

4.3.1 Setting Target Setpoint (SP) of UT130

The following operating procedure describes an example of setting "200°C" for the target setpoint.

<Operating Procedure>

UT130
Display example

Step 1:
Bring the operating display into view.
The measured input value appears on Data display.

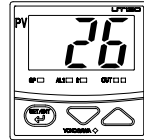

Step 2:
Press the key once, or press the or key to display the target setpoint (SP).
(SP lamp is lit.)

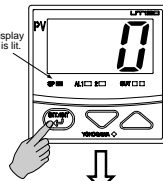

Step 3:
Press the or key to set the required setpoint for the target setpoint.
In this example, "200°C" is set for the target setpoint.

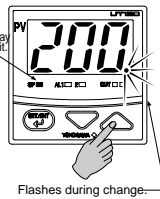

Step 4:
Press the key once to register the setpoint.
The period goes out, then the setting (changing) of target setpoint is completed.

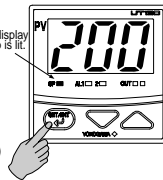

Note 1:
Measured input value (PV) or target setpoint (SP) appears in the operating display.
The action of SP display lamp shows the status of display.
(1) SP display lamp is OFF: PV display (operating display)
(2) SP display lamp is ON: SP display (operating display)
(3) SP display lamp flashes slowly: Displays parameter symbol
(4) SP display lamp flashes rapidly: Changing a parameter setpoint

4.3.2 Setting Target Setpoint (SP) of UT150/UT152/UT155

■ Setting / Changing SP in Operating Display (for Target Setpoint 1: SP1 only)

The following operating procedure describes an example of setting "200°C" for the target setpoint 1.

<Operating Procedure>

UT150/UT152/UT155
Display example

Step 1:
Bring the operating display into view.



Step 2:
Press the or key to set the required value for the target setpoint. In this example, "200°C" is set for the target setpoint.



Step 3:
Press the key once to register the setpoint. The period is lit, then the setting (changing) of target setpoint (SP) is completed.

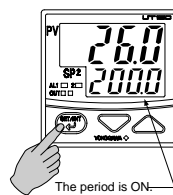

■ Setting / Changing SP in Operating Parameter Setting Display (for SP1 and SP2)

SP can be set or changed in the operating parameter setting display only for the controller with the "/EX" option. And the SP is switched using the external contact input. Refer to "5.6 Using Two Target Setpoints" (Page 5-4).

The following operating procedure describes an example of setting "200.0°C" for the target setpoint 1 (SP1) and "300.0°C" for the target setpoint 2 (SP2).

<Operating Procedure>

UT150/UT152/UT155
Display example

Step 1:
Bring the operating display into view.



Step 2:
Press the key for 3 seconds or more to display the parameter "A1". The parameter "A1" appears only for the controller with the "/AL" or "/HBA" option. The parameter "CTL" appears for the controller without the "/AL" or "/HBA" option

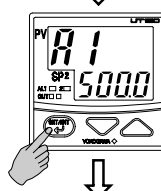

To the next page



From the previous page

Step 3:

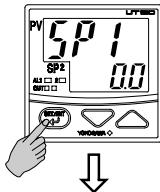
Press the  key several times to display the parameter "SP 1"(target setpoint 1). The parameter "SP 1" appears only for the controller with the "/EX" option.



Step 4

Press the  or  key to set the target setpoint 1 (SP 1). The period flashes while the value is being changed. In this example, "200.0°C" is set for the target setpoint 1.



Flashes during change.

Step 5:

Press the  key once to register the setpoint.

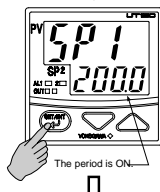



The period is ON.

Step 6:

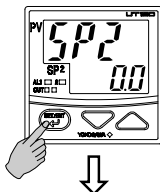
Press the  key several times to display the parameter "SP 2" (target setpoint 2). The parameter "SP 2" appears only for the controller with the "/EX" option.



Step 7:

Press the  or  key to set the target setpoint 2 (SP 2). The period flashes while the value is being changed. In this example, "300.0°C" is set for the target setpoint 2.



Flashes during change.

Step 8:

Press the  key once to register the setpoint.

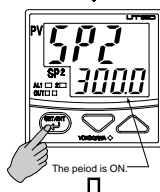

The period is ON.

Step 9:

Press the  key for 3 seconds or more to return to the operating display.

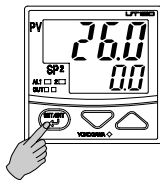

4.4 Setting Alarms

Alarm function is available only for the controller with "/AL" or "HBA" option.

Heater disconnection function is available only for the controller with "/HBA" option.

Timer function is available only for the controller with "/AL/EX" or "/HBA/EX" option.

4.4.1 Setting Alarm Type and Hysteresis

The table below shows the alarm codes and alarm actions.

| Alarm type | Action (Opn and Cls indicate that the relay contact is opened and closed; (on) and (off) indicate that the lamp is on and off; and white triangles indicate temperature control setpoints.) | Alarm type code | | Alarm type | Action (Opn and Cls indicate that the relay contact is opened and closed; (on) and (off) indicate that the lamp is on and off; and white triangles indicate temperature control setpoints.) | Alarm type code | |
|--------------------------------------|--|-----------------------------|---------------------------|---------------------------------------|--|-----------------------------|---------------------------|
| | | Closed contact during alarm | Open contact during alarm | | | Closed contact during alarm | Open contact during alarm |
| No alarm | | OFF | | | | | |
| PV high limit | | 1 11 (See note.) | | De-energized on deviation low limit | | 6 16 (See note.) | |
| PV low limit | | 2 12 (See note.) | | Deviation high and low limit | | 7 17 (See note.) | |
| Deviation high limit | | 3 13 (See note.) | | Deviation within high- and -low-limit | | 8 18 (See note.) | |
| Deviation low limit | | 4 14 (See note.) | | De-energized on PV high limit | | 9 19 (See note.) | |
| De-energized on deviation high limit | | | 5 15 (See note.) | De-energized on PV low limit | | 10 20 (See note.) | |
| Fault diagnosis output | The contact is closed at input burnout. | 21 | | Timer function (De-energized) | | 24 | |
| FAIL output | The output contact is opened in the following events: ¥ Program error ¥ A/D converter error ¥ ROM error ¥ RJC error ¥ RAM error ¥ EEPROM error ¥ power failure | | 22 | | | | |
| Timer function (Energized) | | | 23 | Heater Disconnection alarm | | | 25 |

Note: The alarms numbered 1 to 10 have no waiting action, while alarms 11 to 20 have a waiting action. The waiting action turns off the PV and deviation alarms that occur from the start of the control operation until a stable state is reached.

Waiting action

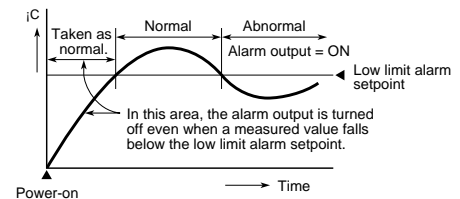

The alarm hysteresis (ON/OFF band) is effective when used as the figure below.

The alarm hysteresis can be set between 0.0 to 100% of measured input range. The setting is a temperature setting.

Example

Alarm 1 type (AL1): PV high limit alarm
Alarm 1 hysteresis (HY1): 5°C
A1 (Alarm 1 setpoint): 100°C

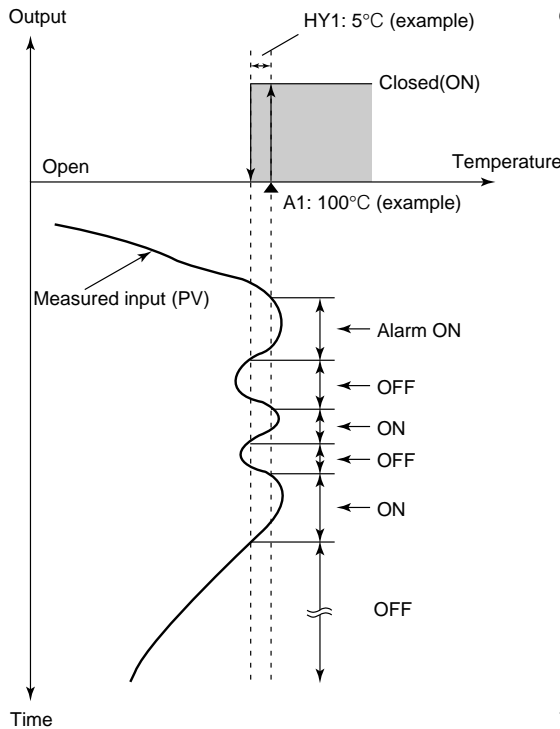

"Open" and "Closed" above show the status of relay output of external contact.

When HY1 = 5°C, the alarm turns on and off too often, and the relay chattering occurs.

➔ Short relay life

Alarm 1 type (AL1): PV high limit alarm
Alarm 1 hysteresis (HY1): 15°C
A1 (Alarm 1 setpoint): 100°C

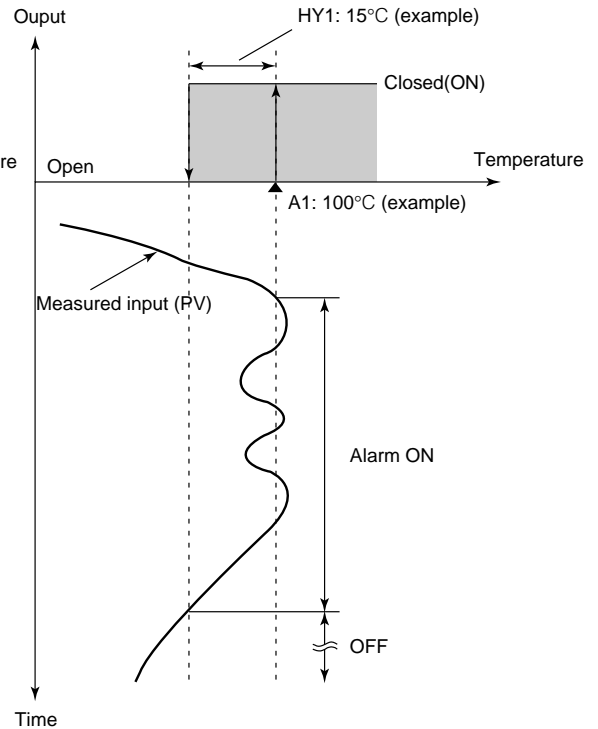

When HY1 = 15°C, the alarm does not turn on and off too often, and the relay chattering does not occur.

➔ Long relay life

The following operating procedure describes an example of setting the “deviation high and low limit” (setpoint: 7) for the alarm-1 type, and “5°C” for the alarm 1 hysteresis.

<Operating Procedure>



Step 1:
Bring the operating display into view.

Step 2:
Press the  key for 3 seconds or more to display the parameter "A1".
The parameter "A1" appears only for the controller with the "/AL" or "/HBA" option.
The parameter "CTL" appears for the controller without the "/AL" or "/HBA" option, and in this case, the alarm function is not available.

Step 3:
Press the  key several times to display the parameter "CTL" (control mode).

NOTE

Set "-1" to enter the setup parameter setting display. But if "LOC" = 1 or 2 is already set, the parameter value can not be changed by setting "LOC" = -1 only. To change the parameter value, set "LOC" = 0 at first (for disabling key lock), then set "LOC" = -1 once again

Step 4 (for UT130 only):
Press the  or  key once to display the setpoint.

Step 5:
Press the  key to display "-1".

Step 6:
Press the  key once.

Step 7:
Press the  key several times to display the parameter "AL1" (alarm 1 type).
The parameter "AL1" appears only for the controller with the "/AL" or "/HBA" option.

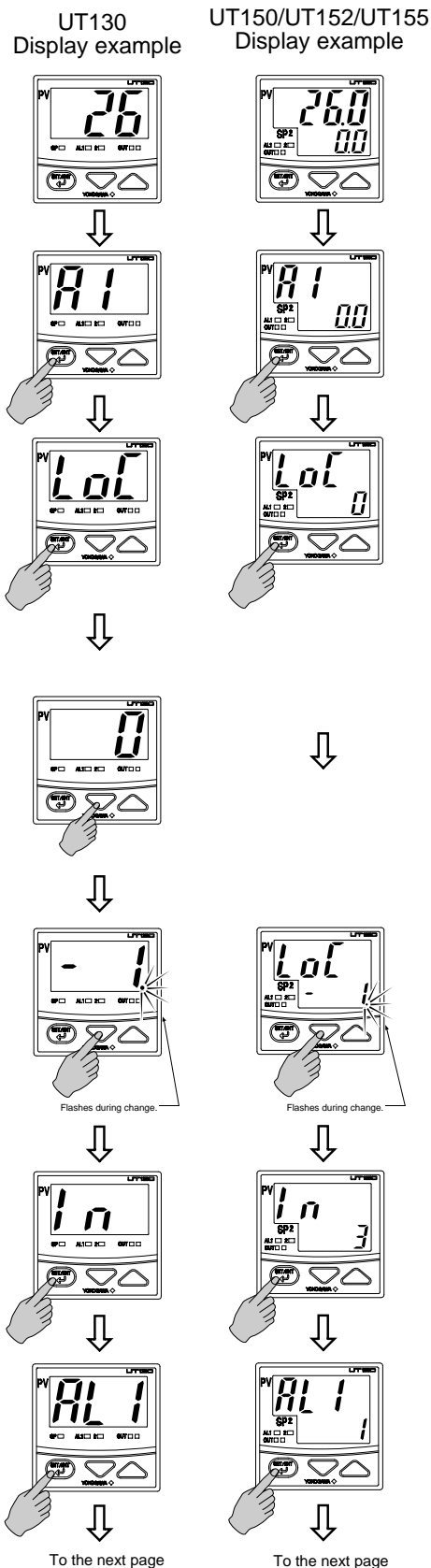

Step 8 (for UT130 only):
Press the Δ or ∇ key once to display the setpoint.

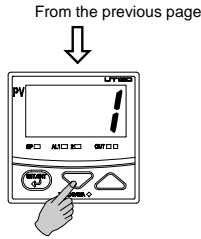

Step 9:
Press the Δ or ∇ key to set the alarm type code. In this example, the "deviation high and low limit" (setpoint: 7) is set for the alarm 1 type.

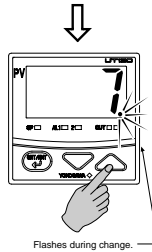

Flashes during change.

From the previous page

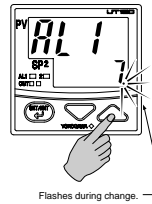

Flashes during change.

Step 10:
Press the OFF key once to register the setpoint.

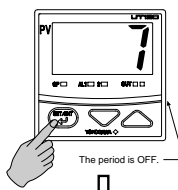

↓

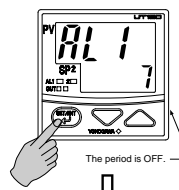

↓

Step 11:
Press the OFF key twice to display the parameter "HY1" (alarm 1 hysteresis).

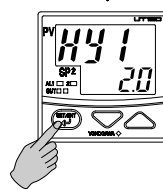
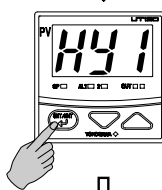

Step 12 (for UT130 only):
Press the Δ or ∇ key once to display the setpoint.



↓

Step 13:
Press the Δ or ∇ key to set the alarm 1 hysteresis. In this example, "5°C" is set for the alarm-1 hysteresis.

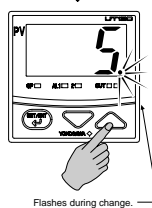

Flashes during change.

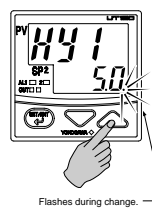

Flashes during change.

Step 14:
Press the OFF key once to register the setpoint.

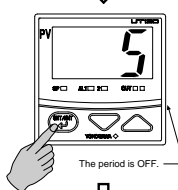

↓

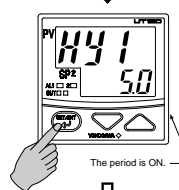

↓

Step 15:
Press the OFF key for 3 seconds or more to return to the operating display

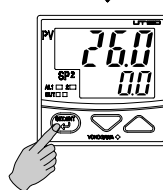
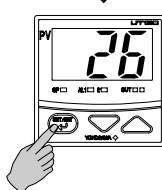

4.4.2 Setting Alarm Setpoint



NOTE

Be sure to confirm the alarm type before setting the alarm setpoint. If the alarm type is changed after setting the alarm setpoint, the alarm setpoint is initialized.

The following operating procedure describes an example of setting "10°C" for the alarm 1 setpoint.

<Operating Procedure>

Step 1:
Bring the operating display into view.

UT130
Display example

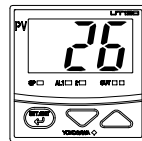

UT150/UT152/UT155
Display example

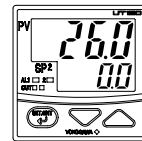

Step 2:
Press the key for 3 seconds or more to display the parameter "A1".
The parameter "A1" appears only for the controller with the "/AL" or "/HBA" option.
The parameter "CTL" appears for the controller without the "/AL" or "/HBA" option, and in this case, the alarm function is not

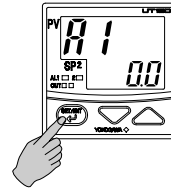
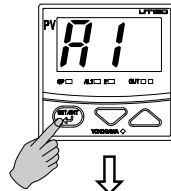

Step 3 (for UT130 only):
Press the or key once to display the setpoint.

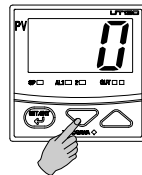

Step 4:
Press the or key to display "10".

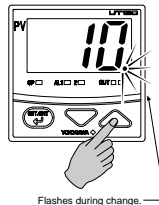

Flashes during change.

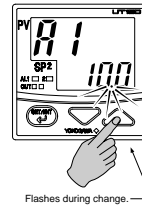

Flashes during change.

Step 5:
Press the key once to register the setpoint.

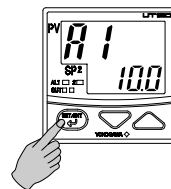
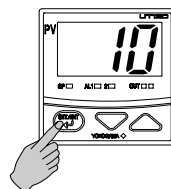

Step 6:
Press the key for 3 seconds or more to return to the operating display.

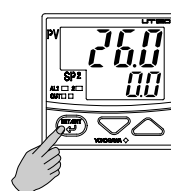
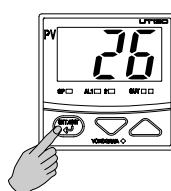

4.4.3 Heater Disconnection Alarm Function

The heater disconnection alarm is the function to detect the deterioration or disconnection of heater by the current value at ON output in ON/OFF control or in time-proportional control.

This function is available for the controller with the "/HBA" option.

Heater disconnection alarm can be used for the alarm 1 only. The heater disconnection alarm is output using the alarm

The heater current sensor used here is the "CTL-6-S-H" or "CTL-12-S36-8" sensor of U.R.D., Ltd.

This sensor is to be purchased by the users themselves.

< Example 1 > Using one heater of 200V AC, 10kW

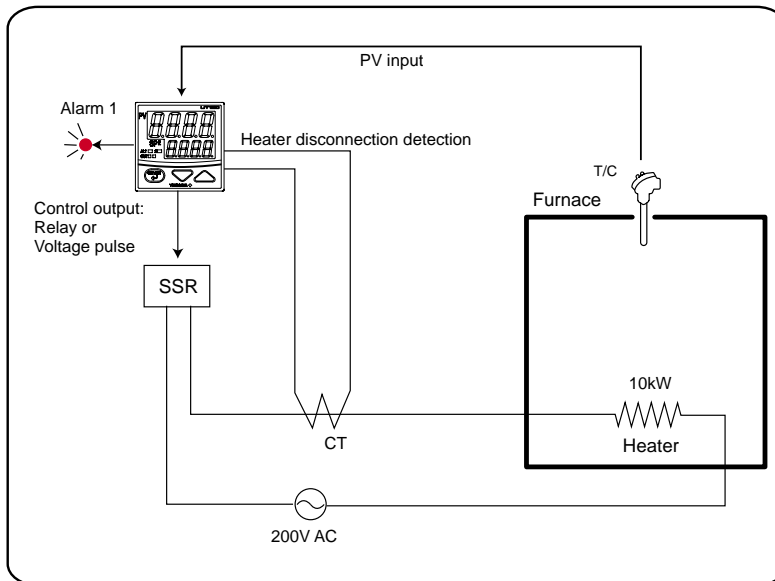

Heater current in normal state

$$\frac{10000W}{200V} = 50A$$

Detecting current error = -5% - 1digit

The setpoint for heater detecting current is -10% of the current value at normal state

Alarm 1 type (AL1) = 25
 Alarm 1 setpoint (A1) = 45A

The controller outputs the heater disconnection alarm when the heater current is 45A or less.

The current value at present can be read in the parameter "HC" (heater current measured value)

< Example 2 > Using three heaters of 200V AC, 5kW

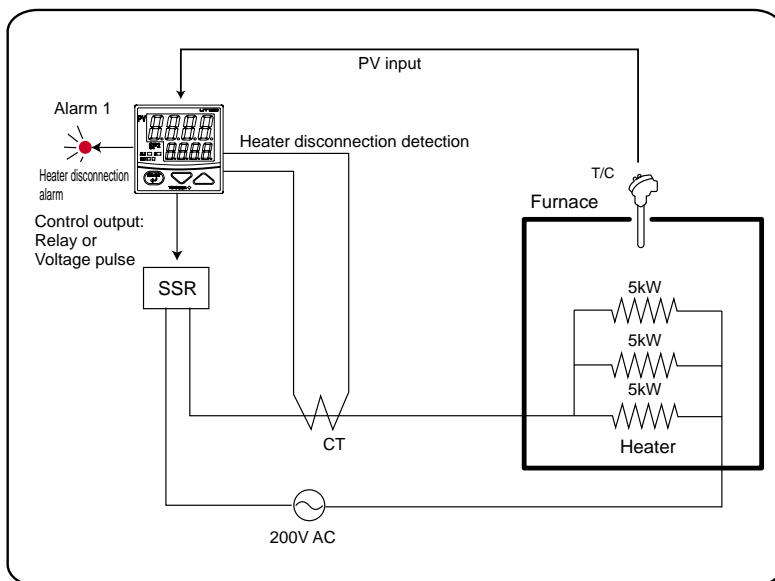

Heater current in normal state:

$$\frac{5000W}{200V} \times 3 = 75A$$

Heater current in one wire disconnection:

$$\frac{5000W}{200V} \times 2 = 50A$$

Detecting current error = -5% - 1digit

The setpoint for heater detecting current is -10% of the current value at normal state

Alarm 1 type (AL1) = 25
 Alarm 1 setpoint (A1) = 60A

The controller outputs the heater disconnection alarm when the heater current is 45A or less.

The current value at present can be read in the parameter "HC" (heater current measured value)

5. APPLIED OPERATIONS

5.1 Changing Measured Input Type and Scale

Example of Temperature Input

-270°C 1370°C

-270°C 1370°C

Parameters to be set for temperature input

1. Measured input type (IN): Set according to a sensor. The display scale cannot be changed. Refer to the Measured Input Ranges (Page 4-1).

Example of Voltage Input

1V 5V

RL RH

Minimum value of measured input scale (RL) Maximum value of measured input scale (RH)

0.0m³/h 50.0m³/h

Parameters to be set for voltage input

1. Measured input type (IN): Set according to input signal. Refer to the Measured Input Ranges (Page 4-1).
2. Decimal point position of measured input (DP): Set the decimal point position of measured input display.
3. Maximum value of measured input scale (RH): Set the maximum value of the scale to be controlled. (Set the displayed value at the maximum value of input signal.)
4. Minimum value of measured input scale (RL): Set the minimum value of the scale to be controlled. (Set the displayed value at the minimum value of input signal.)

- The measured input range is decided by setting the range code for measured input.

- For voltage input, any display scale for measured input can be set.

- The voltage input is available for UT150/UT152/UT155.

Parameter Range

| | |
|----------|---|
| IN | OFF, 1 to 23 |
| DP | Display for voltage input (IN= 20 to 23) 0: No decimal place 1: One decimal place 2: Two decimal places 3: Three decimal places |
| RH RL | Display for voltage input (IN= 20 to 23) -1999 to 9999 However, RL<RH |

5.2 Correcting Measured Input Value

PV input value

+

PV input bias

+

PV value inside the controller

Temperature sensed by thermocouple

Compensation value

Estimated material temperature

Re-heating furnace

- This function allows bias to be summed with input to develop a PV (measured) value for display and control use inside the controller.

- An application example for this function would be measure furnace atmospheric temperature or furnace wall temperature, and add a correction for use as substitute for the heated material temperature.

- This function can also be used for fine adjustment to compensate for small inter-instrument differences in measurement reading that can occur even if all are within the specified instrument accuracy.

- Bias is set using the operating parameter "BS" (PV input bias).

Parameter Range

| | |
|----|--|
| BS | Temperature corresponding to -100 to 100% of PV input range (scale) span |
|----|--|

5.3 Reducing Input Variations

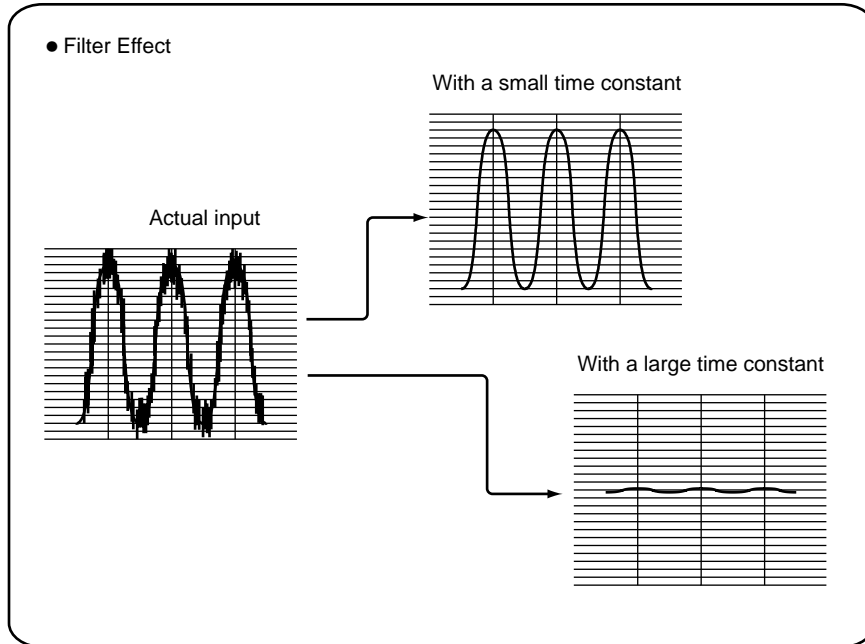

- If input noise or variations cause the low-order display digits to fluctuate so that the displayed value is difficult to read, filtering of inputs will reduce the variations.
- Filtering is used by setting a 1st-order lag time constant; this is set using the parameter "FL" (PV input filter).

Parameter Range

| | |
|----|-----------------------|
| FL | OFF, 1 to 120 seconds |
|----|-----------------------|

5.4 Setting Maximum and Minimum Values of Target Setpoint Range

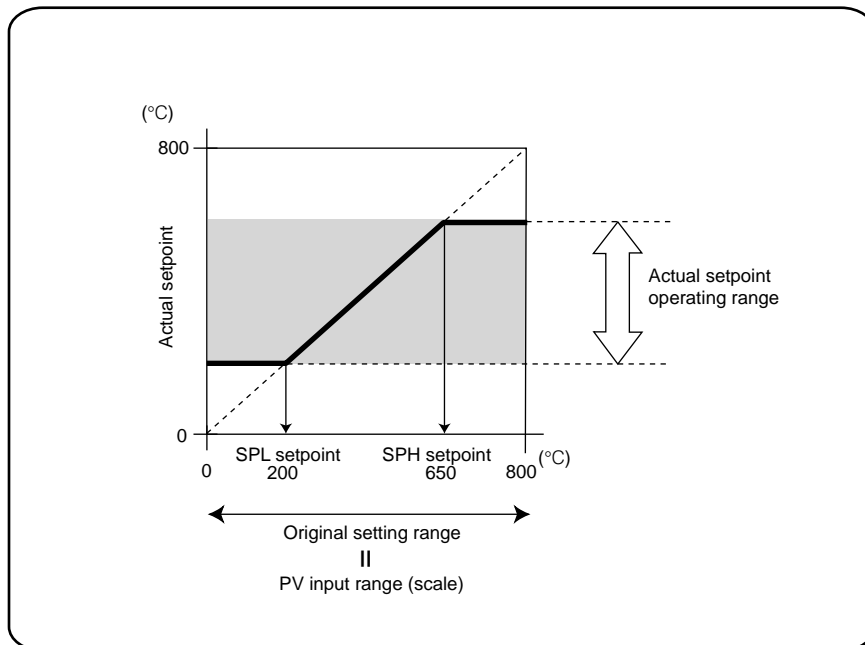

- To stabilize operation or protect equipment, it may be necessary not to allow use of the full setpoint operating range, but rather to some narrower range.
- In such cases, the minimum value and maximum value of target setpoint can be set to restrict the setpoint to the range between those values.
- The minimum value and maximum value of target setpoint are set using the parameters "SPL" (minimum value of target setpoint) and "SPH" (maximum value of target setpoint).

Parameter Range

| | |
|-----|--|
| SPL | Minimum value of PV input range (scale) to (SPH - 1°C) |
| SPH | (SPL + 1°C) to Maximum value of PV input range (scale) |

5.5 Setting Target Sepoint Ramp Rate (Rate-of-Change)

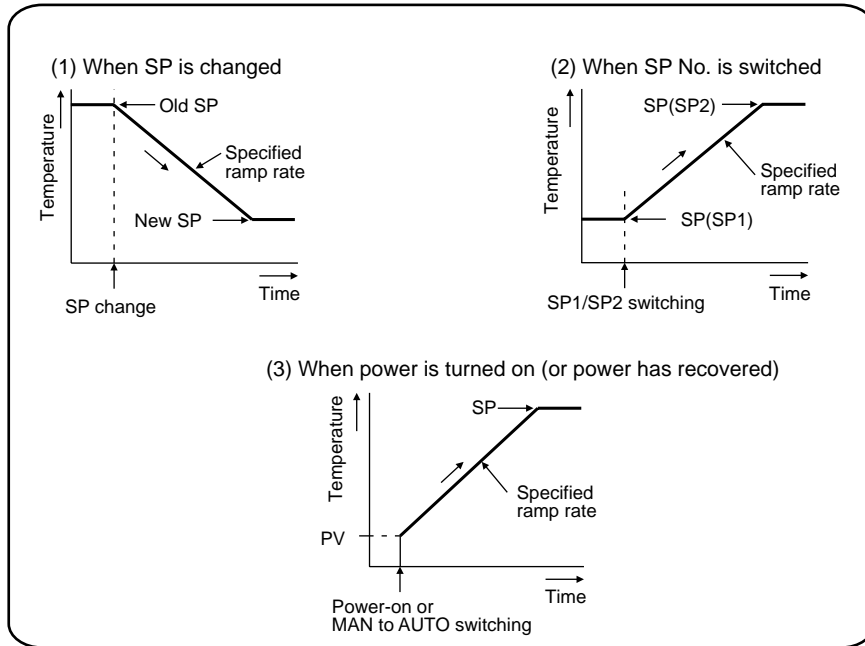

• This function is available for UT150/UT152/UT155.

• To prevent the target setpoint (SP) from changing suddenly or to change it at a constant rate, set the ramp-up rate (UPR) and ramp-down-rate (DNR) for SP. Set the temperature for heat up or heat down per hour or minute for ramp rates.

• The ramp-up rate and ramp-down rate are set using the setup parameters "DNR" and "UPR".
Parameter Range

| | | |
|-----|-----|---|
| DNR | UPR | OFF (no ramp), or Minimum value to maximum value of measured input range (scale) (°C or °F) |
| TMU | | 0: °C or °F / hour 1: °C or °F / minute |

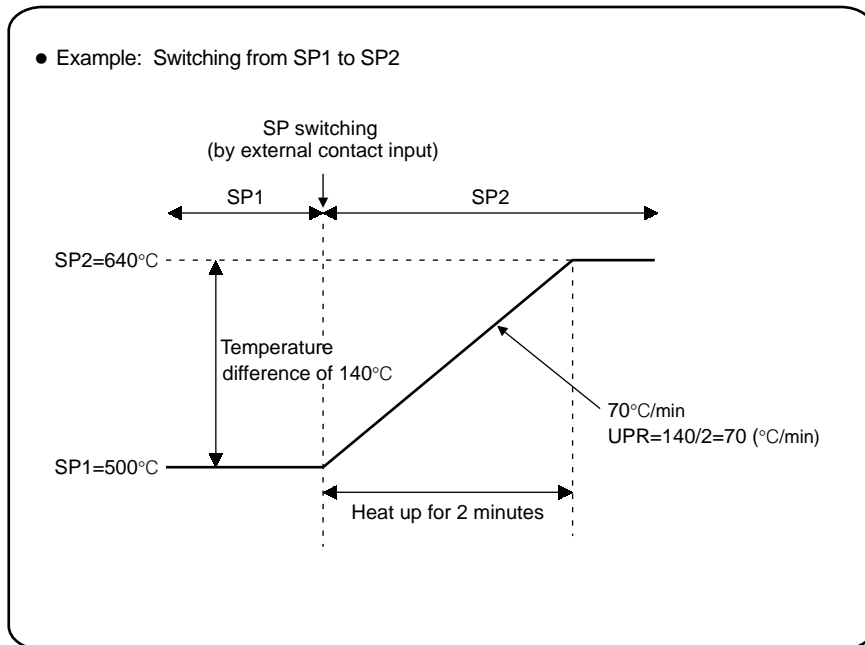

• When switching from SP1 to SP2, SP changes suddenly without setting a ramp rate.

This function is used for changing SP at a constant rate.

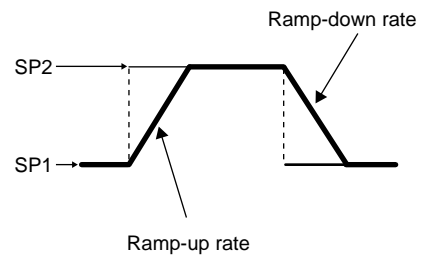

5.6 Using Two Target Setpoints

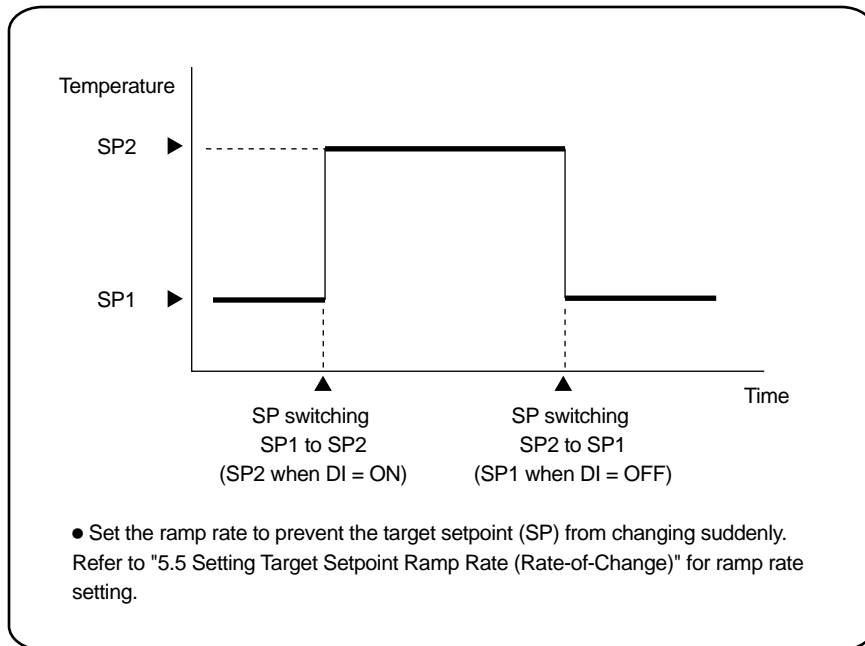

- This function is available for UT150/UT152/UT155 with the "/EX" option.

- SP is switched using the external contact inputs. The external contact input terminals for SP switching are different according to the parameter "DIS" setting. Refer to "8.3 Wiring" on Page 8-7.

- Set "0" or "2" for the setup parameter "DIS" to switch SP.

Parameter Range

| | |
|------------|---|
| SP1 SP2 | Minimum value (SPL) to maximum value (SPH) of target setpoint range (°C or °F) |
| DIS | 0:Timer starts/stops, SP switching 1:Timer starts/stops, RUN/STOP switching 2: RUN/STOP switching, SP switching |

5.7 Retransmission of Measured Input Value in Current Signal

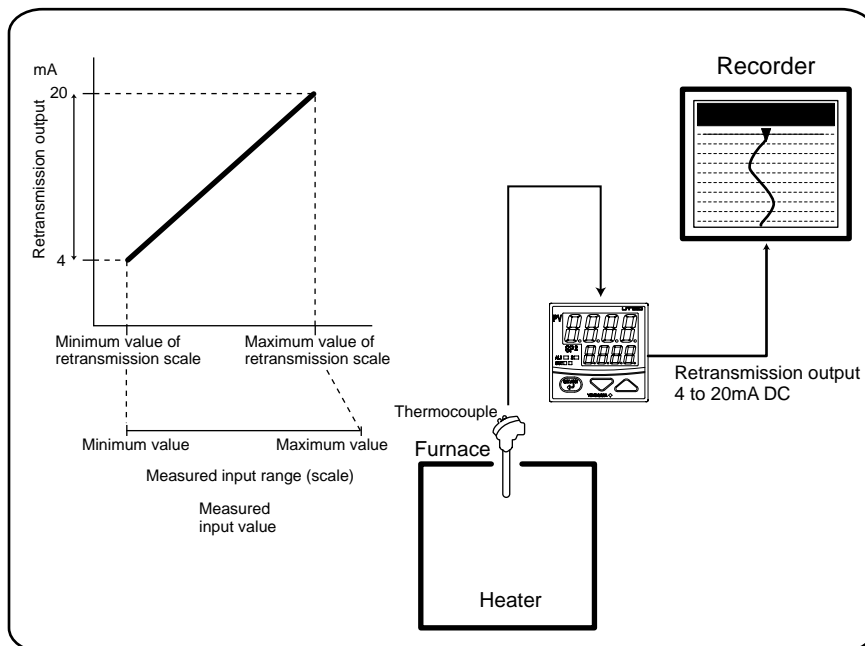

- This function is available for UT150/UT152/UT155 with the "/RET" option.

- The retransmission output range is factory-set to between the maximum and minimum values of measured input range (scale).

- The retransmission output range is changeable. The retransmission output range is set using the parameters "RTL" (minimum value of retransmission output) and "RTH" (maximum value of retransmission output).

Parameter Range

| | |
|-----|---|
| | <Temperature input> Within measured input range |
| RTL | <Voltage input> RTL + 1digit to maximum value of measured input scale (RH) |
| RTH | Minimum value of measured input scale (RL) to RTH —1digit however, RTL < RTH |

5.8 Switching RUN/ STOP

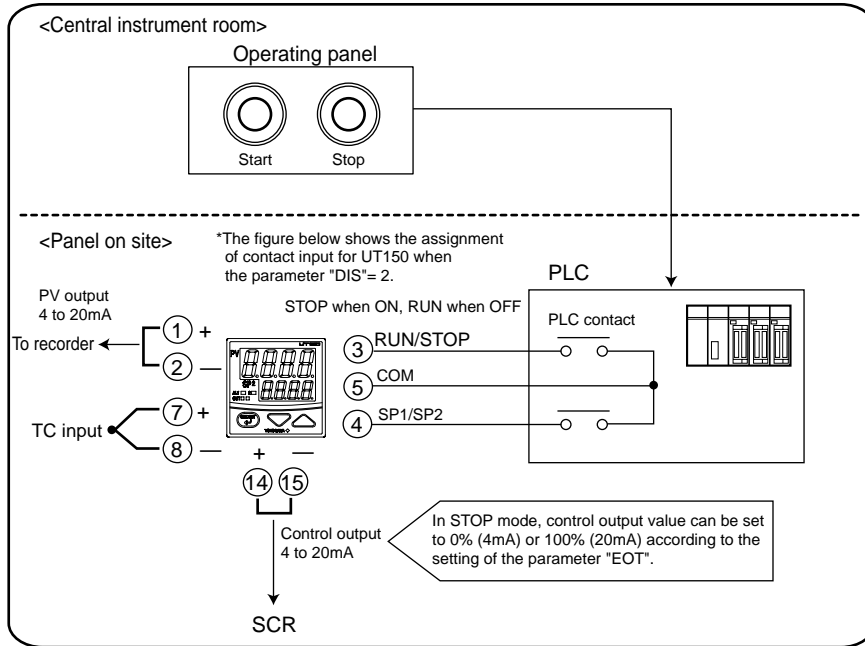

- This function is available for UT150/UT152/UT155 with the "/EX" option.
- RUN/STOP is switched using the external contact inputs. The external contact input terminals for RUN/STOP switching are different according to the parameter "DIS" setting. Refer to the table below.
- Set "1" or "2" for the setup parameter "DIS" to switch RUN/STOP.
- The symbol " STP " and PV value appears alternately on PV display in STOP mode.

Parameter Range

| | |
|-----|---|
| DIS | 0: Timer starts/stops, SP switching 1: Timer starts/stops, RUN/STOP switching 2: RUN/STOP switching, SP switching |
| EOT | 0: 0% (4mA DC) 1: 100% (20mA DC) |

- External contact input terminals for RUN/STOP switching (for UT150/UT152/UT155 only)

| | Parameter "DIS" setpoint | Operating status | Terminal number |
|-----------------|--------------------------|------------------|-----------------|
| UT150 | Setup parameter DIS = 1 | STOP | ④ ON ⑤ |
| | | RUN | ④ OFF ⑤ |
| | Setup parameter DIS = 2 | STOP | ③ ON ⑤ |
| | | RUN | ③ OFF ⑤ |
| UT152/ UT155 | Setup parameter DIS = 1 | STOP | ②② ON ②③ |
| | | RUN | ②① OFF ②③ |
| | Setup parameter DIS = 2 | STOP | ②② ON ②③ |
| | | RUN | ②① OFF ②③ |

- The external contact input terminals for RUN/STOP switching are different according to the setup parameter "DIS" setting.

5.9 Using Timer Function (Turning on External Contact Outputs after the Set Time Elapses)

- The timer function turns on or off external contact outputs when the timer setting time elapses after the external contact input TMR turns on.

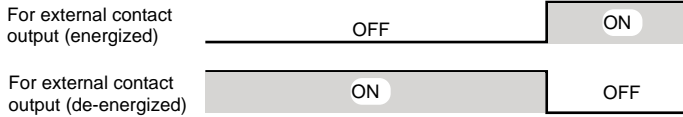
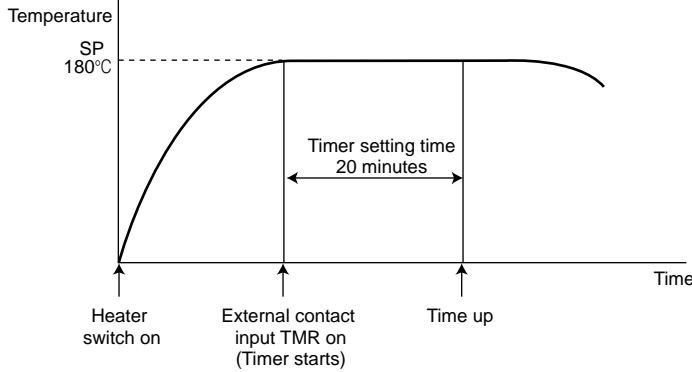

- This function is available for UT150/UT152/UT155 with the "/EX/AL" or "/EX/HBA" option.

- Set "0" or "1" for the setup parameter "DIS" to use Timer. The external contact terminals for startingTimer are different according to the parameter "DIS" setting. Refer to "8.3 Wiring".

- "Energized" or "De-energized" is set using the setup parameters "AL1" and "AL2".

- Time unit is set using the setup parameter "TTU".

- Timer time is set using the operating parameters "T1" and "T2".

- The parameter "T1" is for "AL1", and "T2" is for "AL2".

Parameter Range

| | |
|----|---|
| T1 | Timer time |
| T2 | 0.00 to 99.59(hour and minute or minute and second) |
| | Timer time unit is set by "TTU" |

| | |
|-----|-----------------------------------|
| AL1 | Timer function (energized): 23 |
| AL2 | Timer function (de-energized): 24 |

| | |
|-----|----------------------|
| TTU | Timer time unit |
| | 0: hour and minute |
| | 1: minute and second |

• Timer function (Energized)

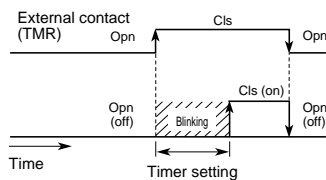

The output contact closes when the timer setting has passed since external contact was closed. Then, the output contact opens immediately when the external contact is opened.

• Timer function (De-energized)

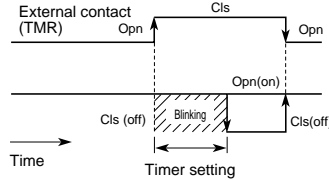

The output contact opens when the timer setting has passed since external contact was closed. Then, the output contact closes immediately when the external contact is opened.

| | |
|-----|---|
| DIS | 0: Timer Starts / Stops, SP switching |
| | 1: Timer Starts / Stops, RUN / STOP switching |
| | 2: RUN / STOP switching, SP switching |

5.10 Setting Key Lock

• The Lock can be set for the parameters of UT100 series controllers. Setting key lock prevents the parameters from being changed intentionally by outsider.

0: No key lock

1: Prevents the parameters from being changed except for the SP in the operating display.

2: Prevents all parameters from being changed.

-1: Set "-1" to enter the setup parameter setting display. But if "LOC" = 1 or 2 is already set, the parameter value can not be changed by setting "LOC" = -1 only. To change the parameter value, set "LOC" = 0 at first (for disabling key lock), then set "LOC" = -1 once again.

Parameter Range

| | |
|-----|---|
| LOC | 0: No key lock 1, 2: Set key lock (refer to the left) -1: Transfer to the setup parameter setting display |
|-----|---|

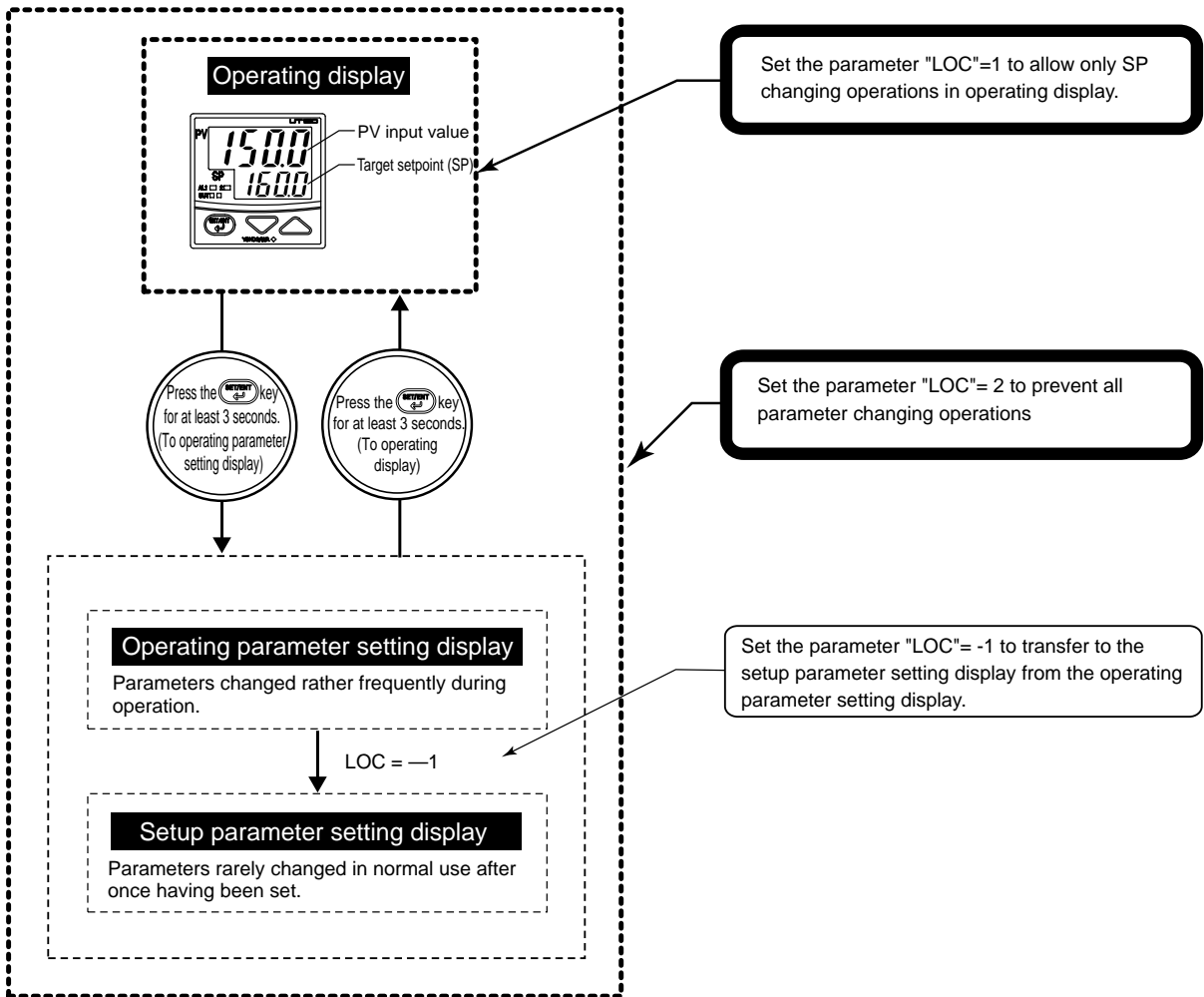

5.11 Selecting Priority of PV/SP Display at Power on (for UT130 Only)

The priority of PV or SP display on operating display can be selected because UT130 has only one data display.

The data (PV or SP) selected in the parameter "DSP" is displayed at power on or when returning to the operating display from the parameter setting display by pressing the  key for at least 3 seconds.

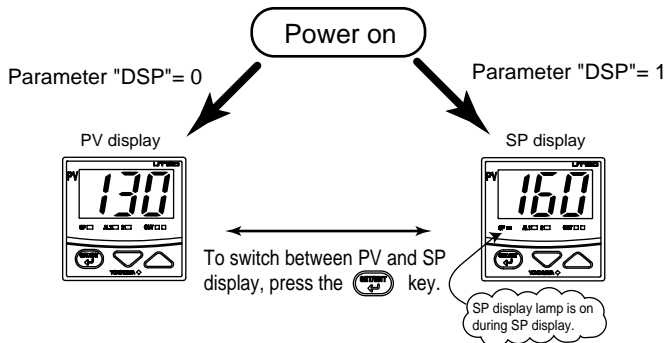

Parameter Range

| | |
|-----|---|
| DSP | 0: Measured value (PV) display 1: Target setpoint (SP) display |
|-----|---|

5.12 Performing Heating/Cooling Control

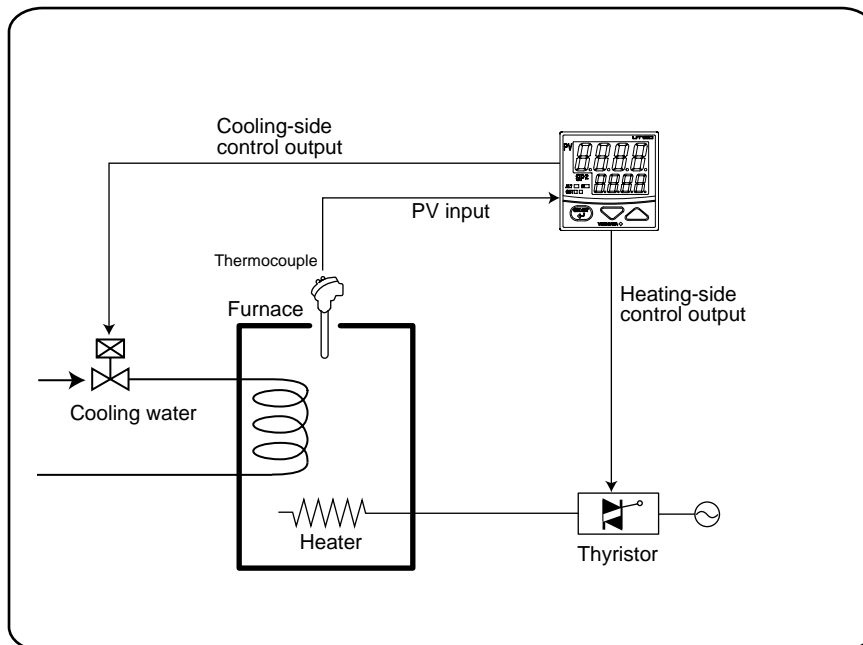

- In heating/cooling control, the controller outputs the result of PID computation after splitting it into heating-purpose and cooling-purpose signals. It is used for the control of heater with heater and cooler.

• Dead band and hysteresis

1. When the dead band in heating/cooling sides is positive (P control)
2. When both the heating and cooling sides are under on/off control.

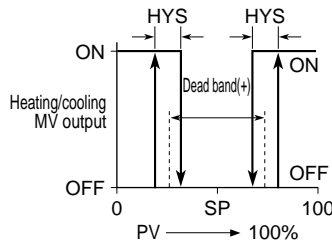
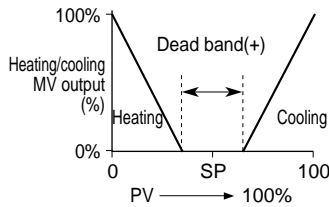

In a positive dead band, there are neither heating-side nor cooling-side outputs.

In a negative dead band, there are both heating-side and cooling-side outputs, which overlap each other.

Parameter Range

| | |
|-----|---|
| DB | < PID control > — (Proportional band setting) to + (proportional band setting) |
| | <On/off control> —50% to +50% of measured input range (scale) span |
| HYS | 0°C /°F to the temperature corresponding to 100% of measured input range (scale) span |
| COL | 0.01 to 9.99 times |

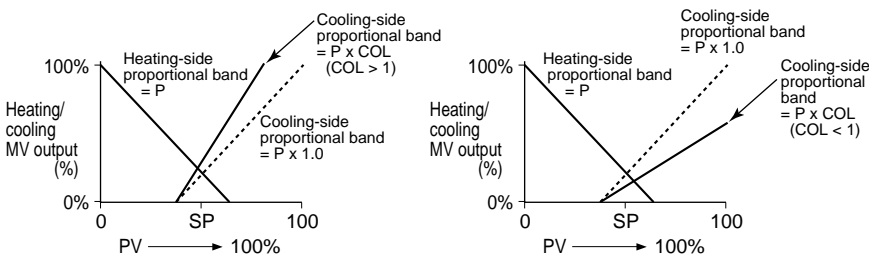

• Heating-side proportional band = Parameter "P" (proportional band)

Cooling-side proportional band = Parameter "P" x Parameter "COL"

• For example, if you set COL=2.0 and the heating-side output is 10% at a certain deviation (SP — PV), then the cooling-side output will be 20% when the cooling-side also reaches that deviation (reverse).

5.13 Communicating with PC or PLC

• Connection Example for Communication

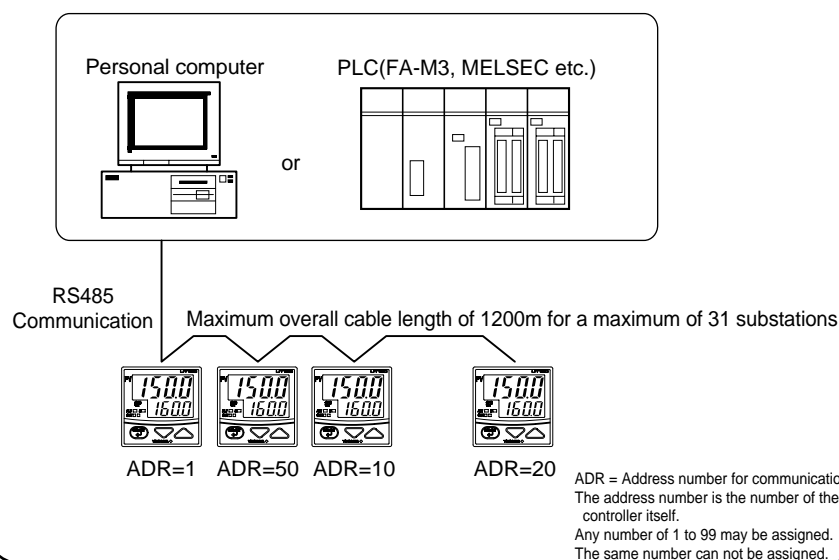

• This function is available for the controller with the "/RS" option.

• For communicating with a PC, RS232C/RS485 converter (model ML1) is necessary.

• Communication with a PLC (FA-M3) manufactured by Yokogawa is through ladder communication module (F3RZ91-0N) or personal computer link module (F3LC11-2N). The communication protocol is ladder or personal computer link.

• Communication with a PLC (MELSEC) manufactured by Mitsubishi is through computer link unit (A1SJ71C24-R24 or A1SJ71C24-R4). The communication protocol is non-procedural ladder.

• How to Communicate (example)

Main data that read (R)/write (W) from/to the temperature controller is possible for:

- PV input (R)
- SP (R/W)
- Control output value (R)
- Error information (R)
- Alarm condition (R)
- Parameter setting value (R)

*For details, refer to the User's Manual "UT100 Series Communication Functions" (IM 05C01E12-10E).

The procedure for SP change
 1. Write "100" to the SP parameter of address-1 controller.
 2. Receive response from address-1 controller.
 3. Write "50" to the SP parameter of address-2 controller.
 4. Receive response from address-2 controller.
 5. Write "160" to the SP parameter of address-3 controller.
 6. Receive response from address-3 controller.

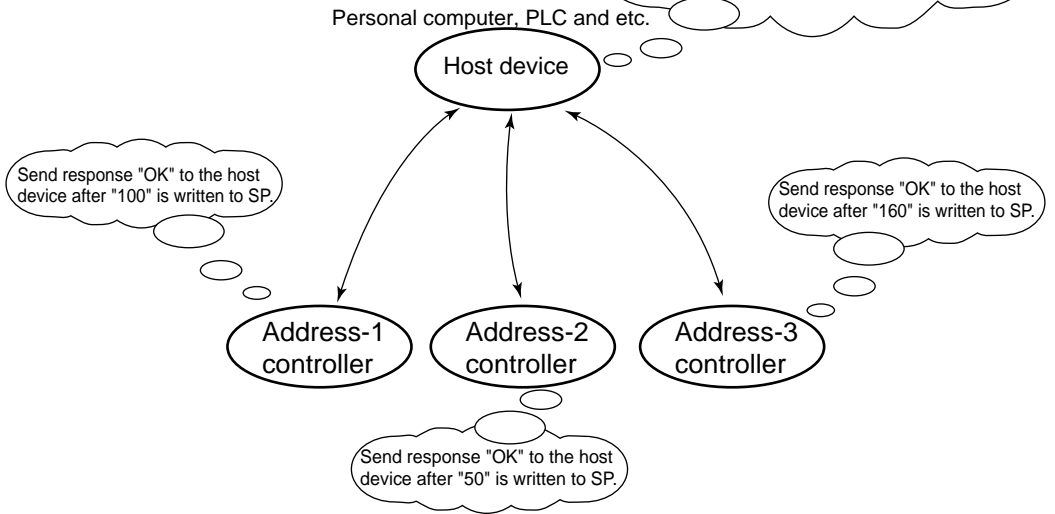

• Communication Protocol

| | |
|---------------------------------------|---|
| Communication Hardware | 2-wire RS-485 communication system |
| Terminal | Terminal numbers: 3 to 5 (UT130/UT150), 26 to 28 (UT152/UT155) |
| Communication Protocol Specifications | PC link communication without sum check PC link communication with sum check Ladder communication MODBUS communication (ASCII mode) MODBUS communication (RTU mode) |
| Maximum Baud Rate | 9600 bps |

• RS-485 Communication Interface

| Item | Specifications |
|---|----------------------------|
| Standard | EIA RS-485 compliant |
| Maximum number of devices to be connected | 31 |
| Communication System | 2-wire, half duplex |
| Synchronization | Start-stop synchronization |
| Communication protocol | Non-procedural |
| Maximum communication distance | 1200 m |
| Baud rate | 2400, 4800, 9600 |

• Parameters to be Set for Communication Functions

| Parameter Name | Symbol | Setting Range | | Default |
|--------------------|--------|------------------------------|---|---------|
| Protocol selection | PSL | PC link communication | 0: without sum check 1: with sum check | 0 |
| | | Ladder communication | 2: Ladder | |
| | | MODBUS communication | 3: ASCII mode 4: RTU mode | |
| Address | ADR | 1 to 99 | | 1 |
| Baud rate | BPS | 0: 2400, 1: 4800, 2: 9600 | | 2: 9600 |
| Parity | PRI | 0: NONE 1: EVEN 2: ODD | | 1: EVN |
| Stop bit | STP | 1, 2 | | 1 |
| Data length | DLN | 7, 8 (*1) | | 8 |

*1: When "2: Ladder" is selected, it is fixed to "8".
 When "3: ASCII mode" is selected for MODBUS communication in protocol selection, the data length is fixed to "7".
 When "4: RTU mode" is selected, it is fixed to "8".

• The details of UT100 Series communication functions need to be the same as those of the communication functions of the host devices to be connected.

• Wiring for Communication

• For UT130/UT150 connection

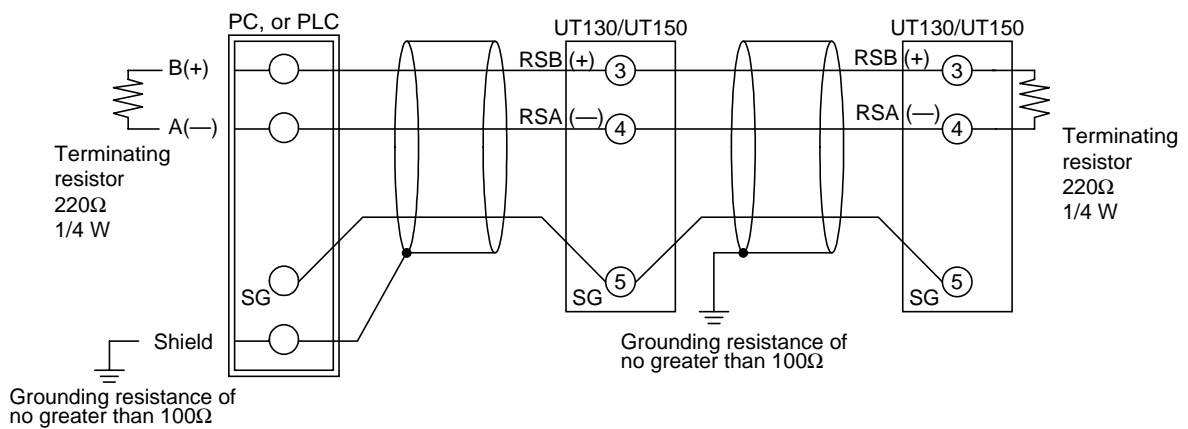

• For UT152/UT155 connection

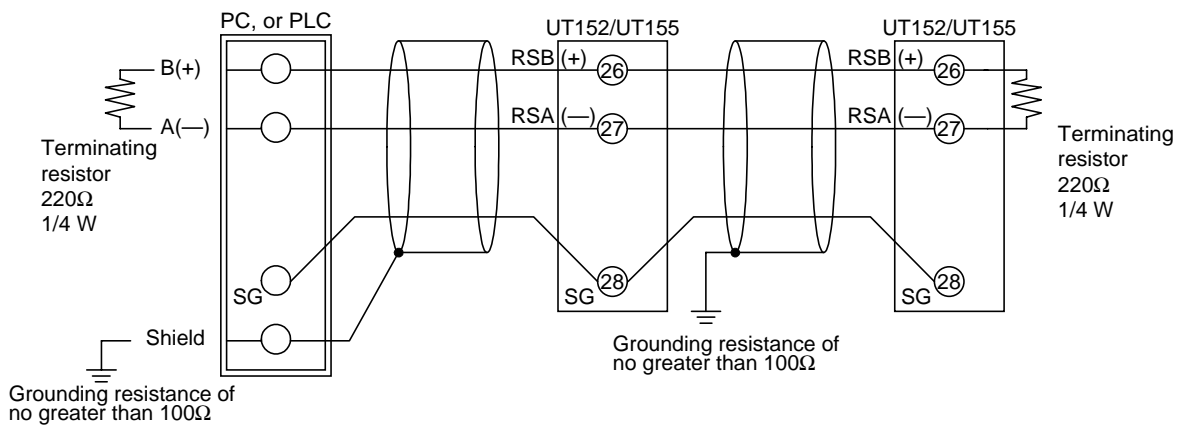

6. DESCRIPTION OF EACH FUNCTION

6.1 ON/OFF Control

6.1.1 ON/OFF Control and Hysteresis

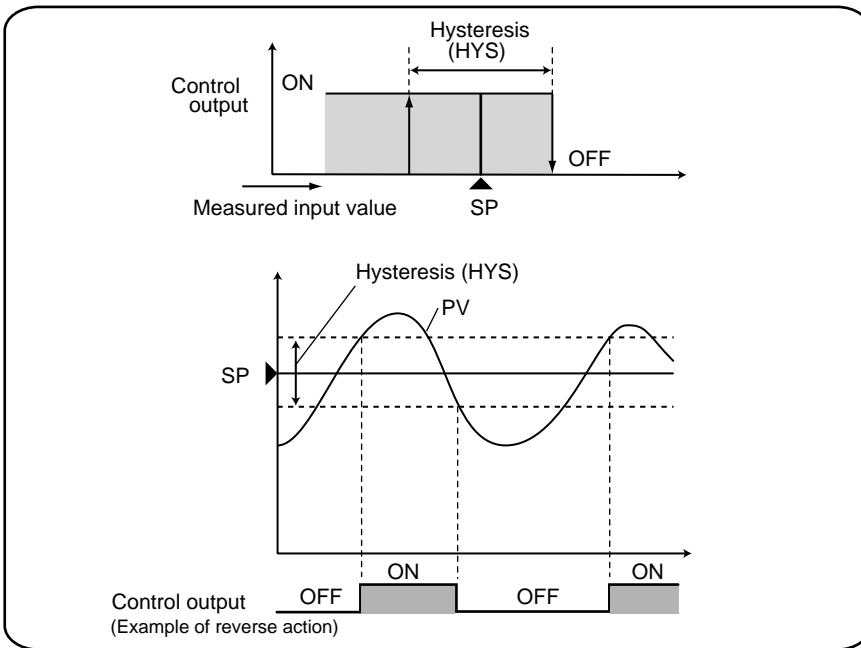

IN ON/OFF control, since the only two possible output states are ON and OFF, the control output cycles are as shown in the accompanying figure. ON/OFF becomes quite narrow, so that if relay output is used, chattering occurs. In this case, the hysteresis should be set wider to prevent relay chattering and for the service life of the relay.

Parameter Range

| | |
|-----|---|
| CTL | ONF: ON/OFF control PID: PID control SLF: Dynamic Auto Tune control |
| HYS | 0 ;C/iF to the temperature corresponding to 100% of the measured input range (scale) span |

6.1.2 ON/OFF Control Application Example

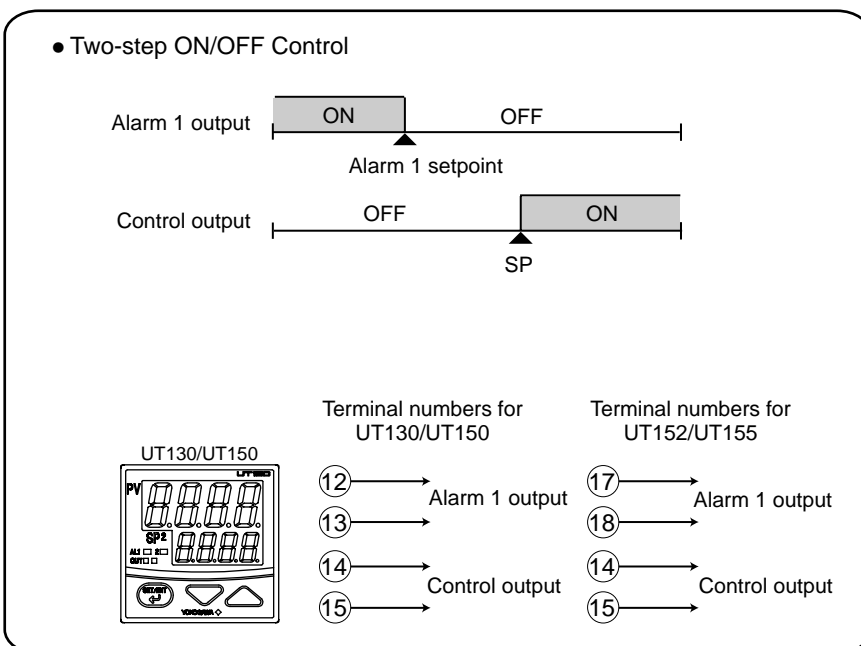



• An example on the left figure shows two-step ON/OFF control using ON/OFF control output and alarm output.

• Alarm 1 is set to PV low limit alarm.

6.2 Proportional (P) Action

6.2.1 Differences between ON/OFF Action and Proportional Action

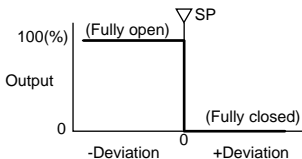
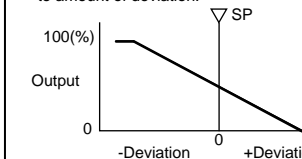
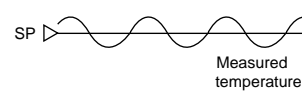
• Differences between ON/OFF Action and Proportional Action

| | ON/OFF action | Proportional Action |
|---------------------------------|--|---|
| Control output (reverse action) | No intermediate state  | Output varies continuously in proportion to amount of deviation.  |
| Control performance | Prone to oscillation  | Smooth control performance  |
| Offset (steady-state deviation) | None | A steady-state deviation (offset) between measured temperature and setpoint is inherent to the operating principle. |

• The proportional band is the parameter that determines the effectiveness of proportional action.

• The figure on the left shows a proportional action by comparison to the simplest control action: ON/OFF action.

6.2.2 Proportional Band (P) Details

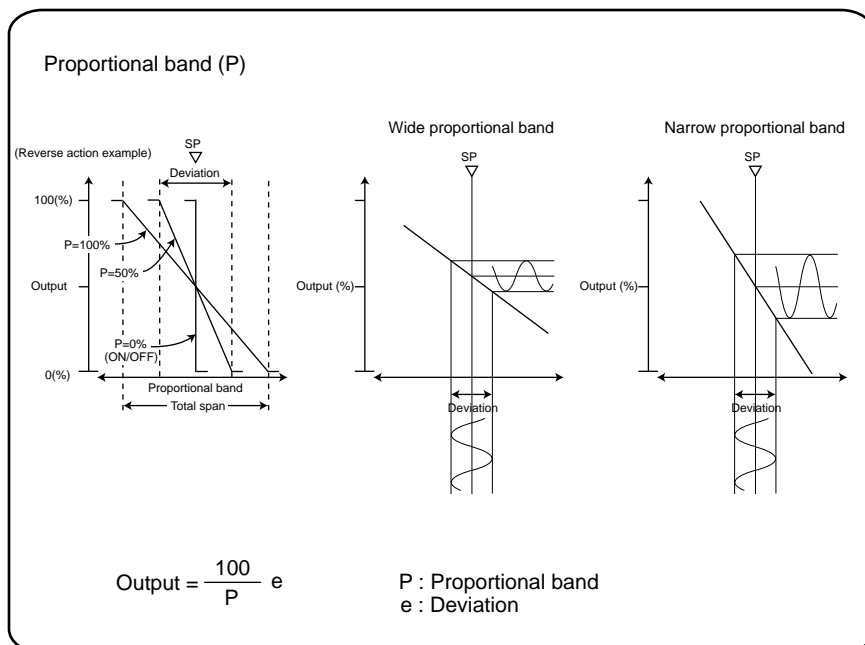

• "Proportional band" is defined as the amount of change* in input (or deviation), as a percent of span, required to cause the control output to change from 0% to 100%.

• Because a narrower proportional band gives greater output change for any given deviation, it therefore also makes the control performance more susceptible to oscillation. At the same time, a narrower proportional band reduces the offset.

• Reducing the proportional band to its smallest limit (proportional band = 0%) results in ON/OFF control. UT100 series controllers select ON/OFF control using the parameter "CTL".

• Note that the unit of proportional band is the percent of PV input span, or actual temperature in engineering units. For UT100 series, set the actual temperature.

6.2.3 Tuning the Proportional Band

To fine-tune a proportional band obtained using auto-tuning, or to manually tune the proportional band:

- Work from larger to smaller numbers (wider to narrower)
- If cycling appears, that means that the proportional band is too narrow.
- Proportional band tuning cannot cancel an offset.

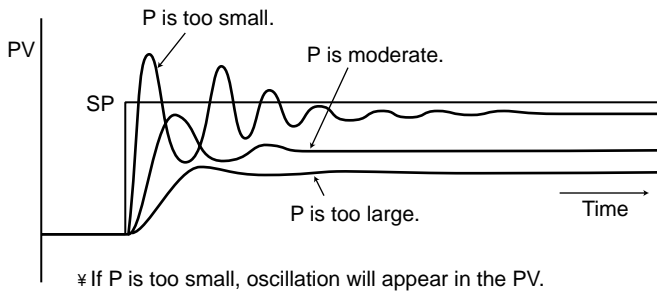

- The proportional band (P) is adjusted as shown in the figure on the left.

Parameter Range

| | |
|---|--|
| P | 1°C/°F to the temperature corresponding to 100% of measured input range (scale) span |
|---|--|

6.3 Integral (I) Action

6.3.1 Integral Time (I)

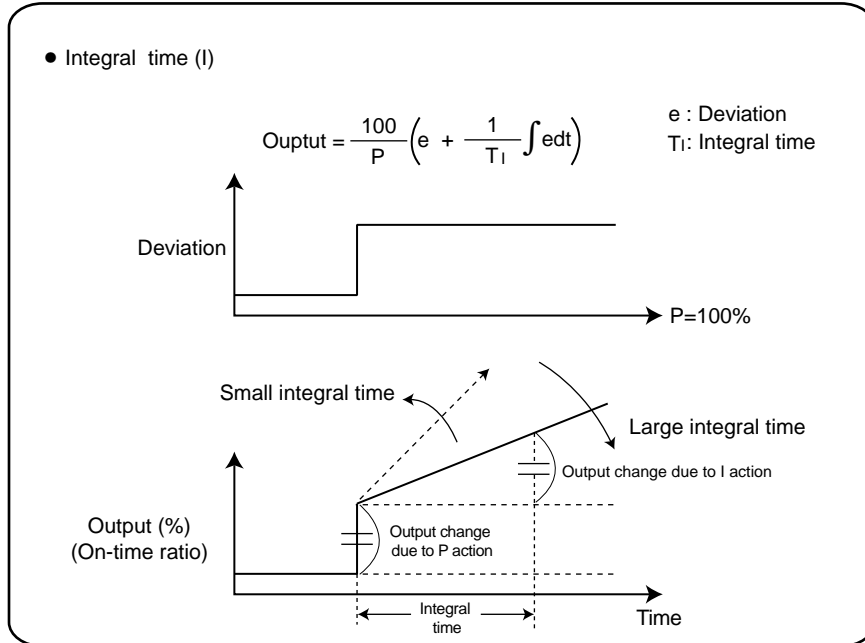

• "Integral action" ("I" action) is a function that will automatically diminish the offset (steady-state deviation) that is inherently unavoidable with proportional action alone. The parameter that specifies how the integral action will operate is the integral time (I). The integral action continuously increases or decreases the output in proportion to the time integral of the deviation (the product of the deviation and the time that the deviation continues).

• Integral action is normally used together with proportional action as proportional-plus-integral action (PI action).

Parameter Range

| | |
|---|--|
| I | UT130: 1 to 999 sec or OFF |
| | UT150/UT152/UT155: 1 to 3600 sec or OFF |

• The integral time (I) is defined as the time required to develop, when a stepwise change in deviation is imposed, an output change due to integral action that is exactly equal to the change due to proportional action. The longer the integral time set, the slower the change in output; the smaller the time, the faster the output changes.

• If integral action is not to be used, the integral parameter is set to OFF.

6.3.2 Tuning the Integral Time

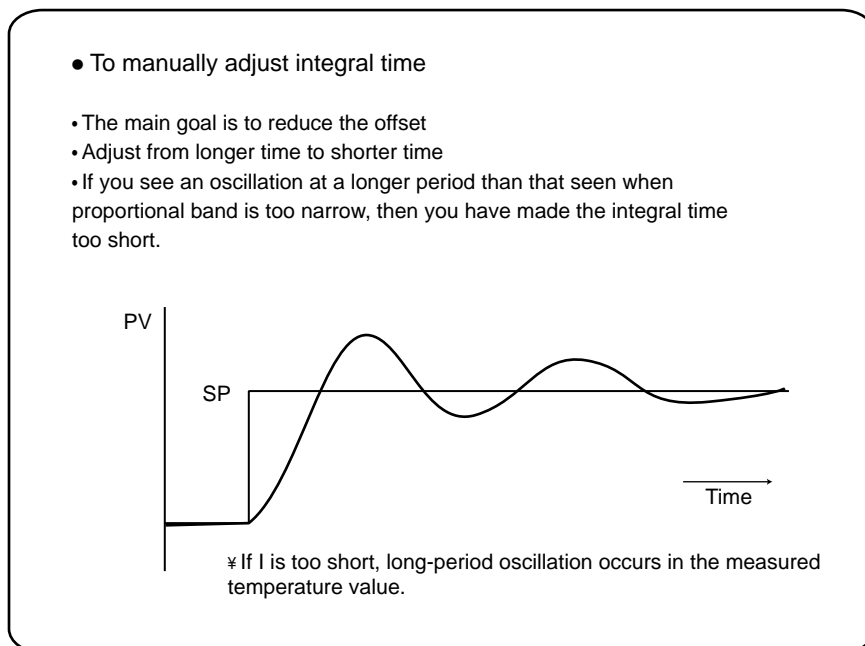

• When I action is OFF, change the operating parameter "MR" (Manual reset) to remove the offset.

• Shortening the integral time, like narrowing the proportional band, will cause the measured temperature to begin oscillating. However, oscillation due to integral action is characterized by a longer period than that of oscillation due to narrow proportional band.

Parameter Range

| | |
|----|--|
| MR | UT130: -19.9 to 99.9% |
| | UT130 (heating/cooling type) and UT150/UT152/UT155: -100 to 100% |

6.4 Derivative (D) Action

6.4.1 Derivative Time (D)

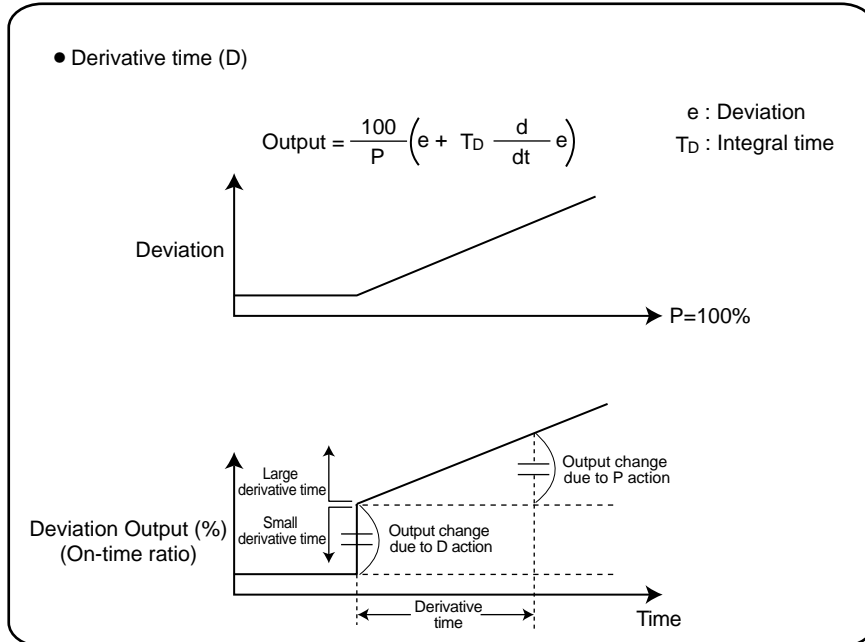

- If the control object has a large time constant or dead time the corrective action will be too slow with proportional action or proportional-plus-integral action alone, causing overshoot. However, even just sensing whether the deviation is on an increasing or a decreasing trend and adding some early corrective action can improve the controllability. Thus the derivative action ("D" action) is action that changes the output in proportion to the deviation derivative value (rate-of-change). The parameter that sets how the derivative action will operate is the derivative time (D).

- The derivative time (D) is defined as the time required with "PD" action to develop, when a constant-slope-change in deviation is imposed, an output change due to derivative action that is exactly equal to the change due to proportional action.

6.4.2 Tuning the Derivative Time

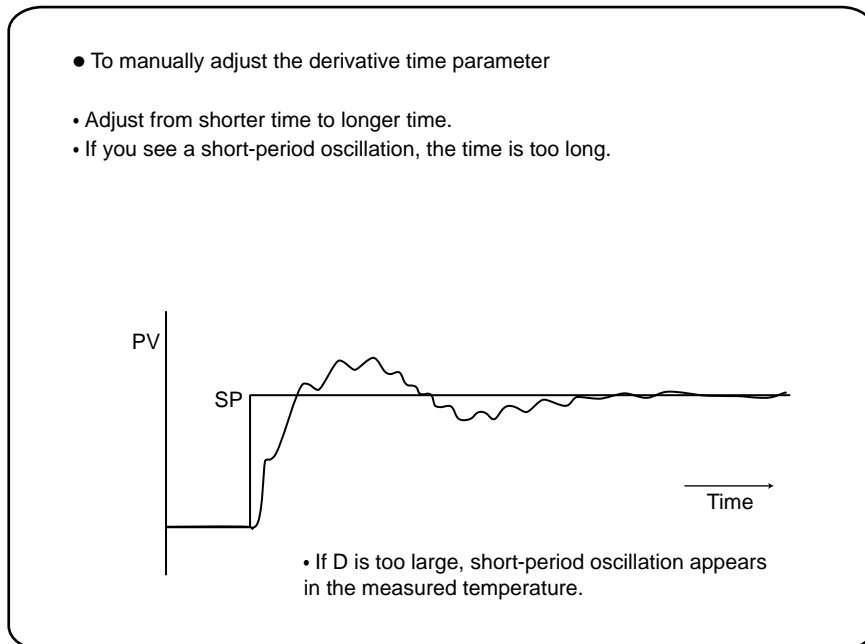

- The longer the derivative time is set, the stronger the corrective action is, and the more likely the output will become oscillatory. Oscillations due to derivative action are characterized by a short period.

- When the derivative time (D) is set to OFF, the derivative action does not function. D=OFF should always be used when controlling fast-responding inputs such as pressure and flow, or inputs characterized by rapid fluctuation, such as optical sensors.

Parameter Range

| | |
|---|----------------------|
| D | UT130: |
| | 1 to 999 sec or OFF |
| | UT150/UT152/UT155: |
| | 1 to 3600 sec or OFF |

6.5 Dynamic Auto Tune Control and PID Control

6.5.1 Dynamic Auto Tune Control

"Dynamic Auto Tune Control" is a sort of self-tuning

Dynamic Auto Tune Control is effective in the following cases:

- (1) When the output travels up to 100% or down to 0% and remains there at power on;
- (2) When the output travels up to 100% or down to 0% and remains there after changing a setpoint;
- (3) When the process begins oscillating by disturbance and the like

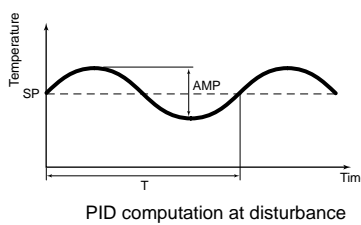
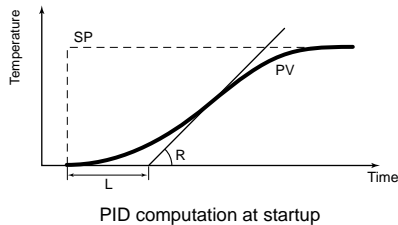

● What is Dynamic Auto Tune Control?
 Dynamic auto tune control is one of the features offered by the temperature controller. When the controller is tuned on or the measured input (PV) starts "hunting", this mode of control monitors the behavior of the PV and/or OUT (control output value) to automatically determine the optimum PID constants. This means that the PID constants may be changed automatically. If this is not desirable for your system, operate the controller in the normal "PID control". If you want to automatically determine the PID constants at the initial startup of the controller, first define the target setpoint (SP) and then turn the controller off once and then back on again. Do not use Dynamic auto tune control for a system where there is interference or continual disturbances.

Parameter Range

| | |
|-----|---|
| CTL | ONF: ON/OFF control PID: PID control SLF: Dynamic auto tune control |
|-----|---|

Precautions

To use Dynamic auto tune control,

- (1) be sure to turn on the final control element, such as a heater, before starting the control, and
- (2) make sure that the controlled loop is a closed loop.

If you do not follow these precautions, improper PID constants may be written into the controller. If this occurs, carry out the following:

- Set PID for the parameter "CTL".
- Set the factory-set defaults [P = (upper range(scale)-limit — lower range (scale)-limit) x 5%; I = 240sec; and D = 60sec] for the PID constants.
- Set SLF for the parameter "CTL".

If the control still doesn't work properly, stop using the Dynamic auto tune control function. Change the parameter "CTL" setting to PID and execute auto-tuning to obtain the PID constants.

6.5.2 Manually Tuning PID Constants

- Procedure for manually tuning PID constants

$$\text{Output} = \frac{\text{Temperature input span}}{P} \left(e + \frac{1}{T_I} \int e dt + T_D \frac{d}{dt} PV \right)$$

e : Deviation
 P : Proportional band
 PV: Measured input value
 T_I : Integral time
 T_D : Derivative time

- (1) In principle, auto tuning must be used.
- (2) Turn PID parameters in the order of P, I, D. Adjust a numeric slowly by observing the result, and keep notes of what the progress is.
- (3) Gradually reduce P from a larger value. When the measured value begins to oscillate, stop tuning and increase the value somewhat.
- (4) Also gradually reduce I from a larger value. When the measured value begins to oscillate (with long period), stop tuning and increase the value somewhat.
- (5) Gradually increase D from a smaller value. When the measured value begins to oscillate (with short period), stop tuning and lower the value slightly.

- PID based output can be obtained by the equation on the left. Take this into account when tuning PID parameters. Manual PID tuning procedure is as described in (2) to (5) on the left.

6.5.3 PID Auto-Tuning

- Auto-tuning (AT)
- Automatic PID constant setting function
- Uses a limit cycle method

The auto-tuning temporarily executes ON/OFF control, calculates appropriate PID constants from response data obtained, and sets these constants.

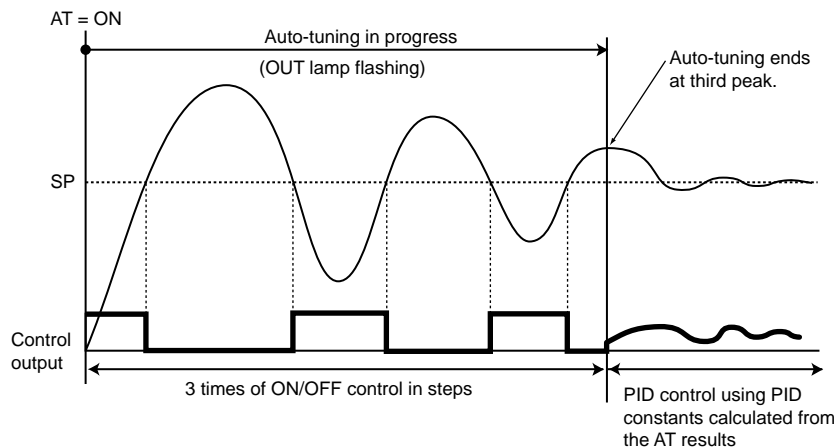

- The temperature controller automatically measures the process characteristics and sets PID constants, which are control parameters, to optimum values for the setpoint.
- Auto-tuning can be executed using simple key operations.
- When auto-tuning starts, the temperature controller becomes an ON/OFF controller, with its output alternating between 100% and 0%.

Do not use auto-tuning in the following processes:

- Fast-response processes such as pressure and flow
- Processes in which control output ON/OFF switching is inappropriate

- Auto-tuning time is different according to the process. The longest time is 24 hours.

6.6 Control Output

6.6.1 Time Proportional PID Output (Relay Output / Voltage Pulse Output)

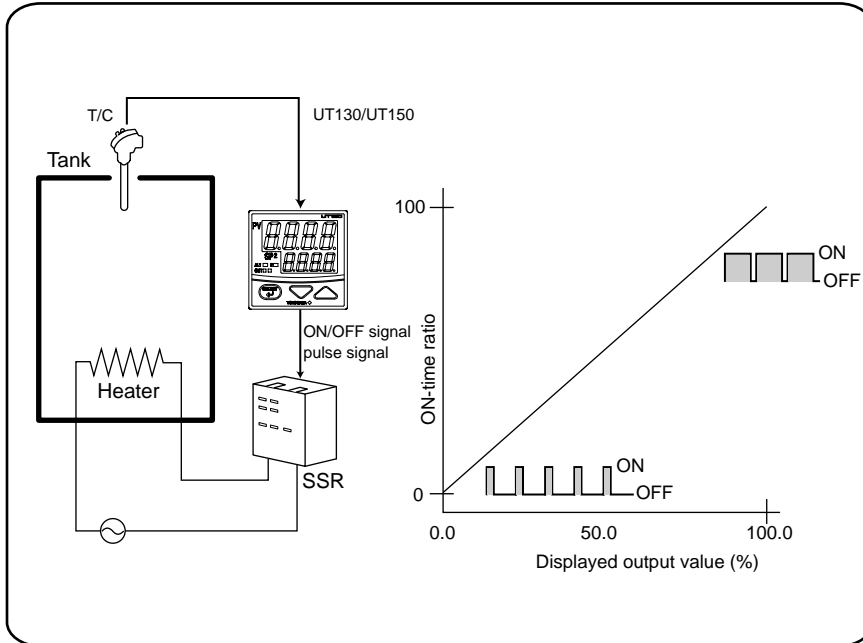

- This function is available for UT130-RN or -VN, UT15X-RN or —VN.

- In time proportional PID, the PID computation result is output in the form of an ON/OFF signal pulse width.

- The fraction of the cycle time (shown below) during which output is ON (ON-time ratio) is proportional to the displayed output value (PID computation value).

- This function is primarily used in electrical heating control.

| | |
|----------------------|---|
| Relay output | Contact rating: 250V AC, 3A (resistance load) |
| Voltage pulse output | ON voltage: 12V DC OFF voltage: 0.1V DC or less (Load resistance: 600% or more) |

6.6.2 Cycle Time

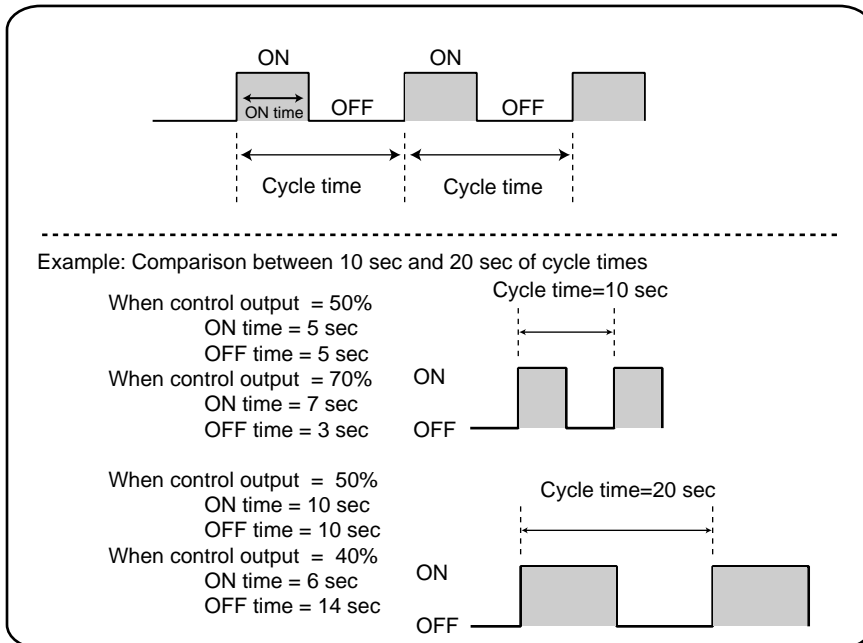

- This function is available in time proportional control.

- Cycle time is the basic cycle period for a signal full cycle of ON/OFF operation for a relay or voltage pulse output.

- Reducing cycle time results in faster cycling and finer control. In general, setting about one tenth of the time constant of control object is standard.

- For relay output, 20 seconds or more of cycle time is recommended for relay life.

- Cycle time can be set using the setup parameter "CT". Cooling-side control output cycle time can be set using the setup parameter "CTC".

Parameter Range

| | |
|-----|--------------|
| CT | 1 to 240 sec |
| CTC | |

6.6.3 Continuous PID Output (4 to 20mA DC)

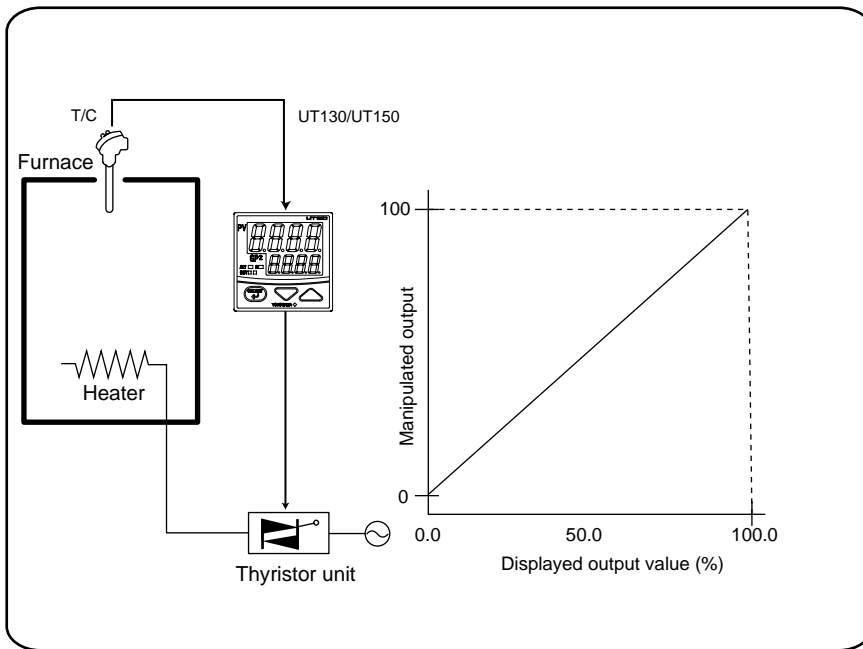

- This function is available for UT150X-AN.

- In continuous PID output, the PID computation result is output as a continuous analog signal. The analog signal that serves as manipulated output (4 to 20mA DC) is proportional to displayed output value (PID computation value).

- This output type is used to drive final control elements such as thyristors, electro-pneumatic converter + pneumatic control valve combinations, and electrical positioner + motor-driven valve (or control motors) combinations.

| | |
|---------------------|---|
| 4 to 20mA DC output | Load resistance: 600% or less Output accuracy: -0.3% (of maximum output) |
|---------------------|---|

- Output circuit: Isolated from measured input. Not isolated from heating and cooling sides nor from retransmission outputs.

6.7 Overshoot Suppressing Function “SUPER”

6.7.1 “SUPER” Operating Principles

- "SUPER" is effective in the following cases.
- Overshoot must be suppressed.
- Rise-up time needs to be shortened.
- Load varies often.
- SP is changed frequently.
- The "SUPER" function is effective when used together with the Auto-Tune (AT) function.

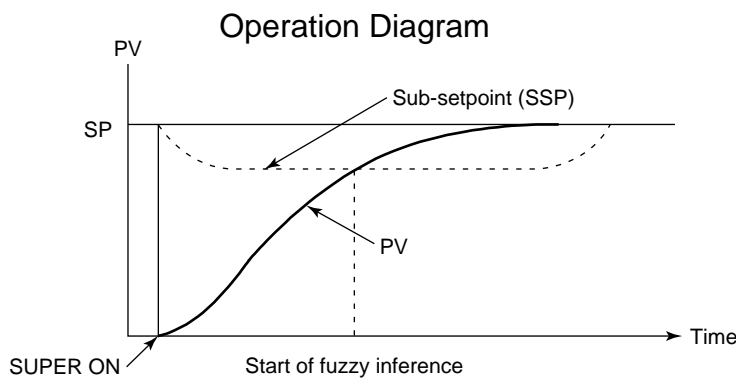

- The "SUPER" function monitors the deviation for evidence that there is a danger of overshoot, and on sensing such danger automatically changes the setpoint temporarily to a somewhat lower value (sub-setpoint "SSP").

- Once the danger of overshoot appears diminished, the function returns the effective setpoint gradually to the true setpoint.

- "Fuzzy inference" techniques are employed in the algorithms used to change the setpoint to the lower temporary value, and to return it gradually to the true setpoint.

Parameter Range

| | |
|----|---------|
| SC | OFF, ON |
|----|---------|

6.7.2 Effects of “SUPER”

SUPER effects (1)

Example of overshoot suppression control for setpoint changes

Process: Small electric furnace
 P = 1.5% I = 128 sec D = 32 sec
 (from auto-tuning)

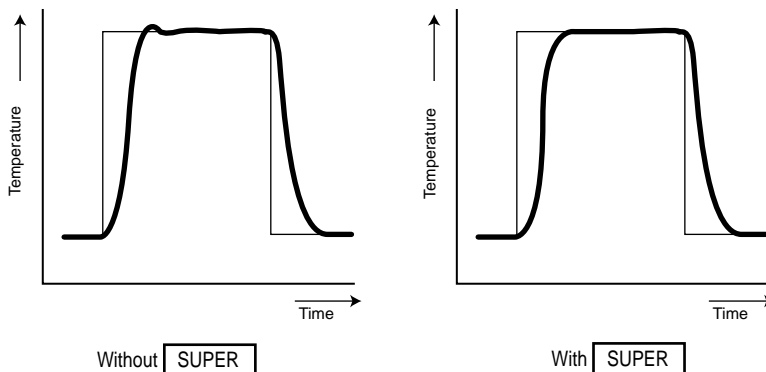

- If the optimum PID values are being used, then use of the "SUPER" function yields stable control without overshoot even on setpoint changes.

- As a result, temperature up-ramps follow the programmed pattern more closely, giving more consistent product quality.

- "Overshoot" is not only a matter of temperature exceeding the setpoint, but also of prolonged instability and slow settling resulting from the undershoot that occurs in reaction to the overshoot.

SUPER effects (2)

Example of ramp to soak transition overshoot suppression control

Process: Small electric furnace
P = 1.8% I = 317 sec D = 79 sec
(from auto-tuning)

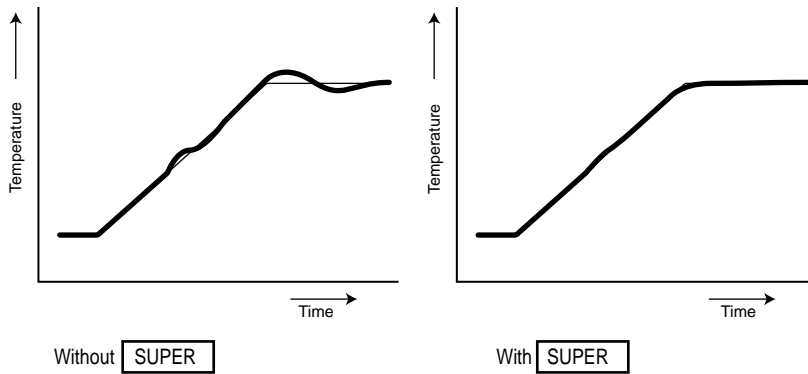

- Due to the gain changes that occur at the transition from ramp to soak, conventional controls are inevitably prone to overshoot. Yet, if the PID constants are set so that the output stabilizes more quickly in order to avoid overshoot, the temperature ramp will lag behind the prescribed pattern.

- By using the "SUPER" function, the temperature up ramp can be made to follow the pattern almost exactly, and significant savings can be achieved.

SUPER effects (3)

Example of overshoot suppression control on response to disturbances

Process: Kiln
P = 6.2% I = 311sec D=77 sec
(from auto-tuning)

Process: Kiln
P = 4.3% I = 684 sec D = 171 sec
(from auto-tuning)

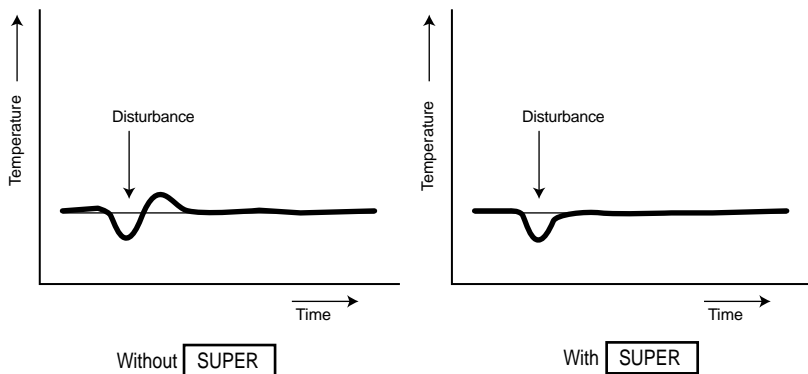

- The "SUPER" function is extremely effective for improving response to disturbances. The overshoot experienced with conventional PID control in correction for disturbances is significantly reduced, and settling time is greatly speeded up.

7. TROUBLESHOOTING

In the event of an abnormality, perform the following checks as outlined by the flowchart.

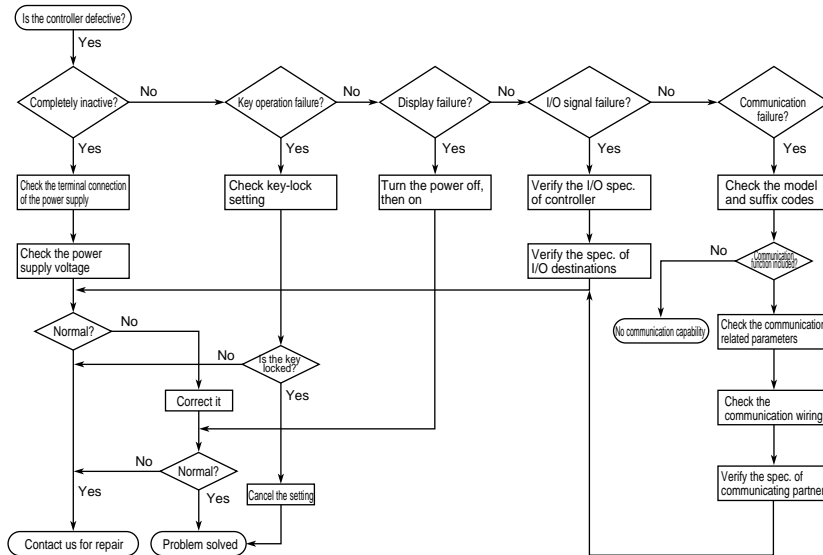

■ Error Display during Operation

(1) If the controller displays one of the following, carry out the appropriate remedy for the particular error.

| Display | Error content | Remedy |
|-------------------------------|---|---|
| <i>P.Er</i> P.Er | The parameter is abnormal | Check the settings of all the parameters and set them at their proper values. |
| <i>b.o</i> B.o | Input burnout | Check the sensor wiring and correct it. |
| <i>ooo</i> OOO | PV over-scale (PV exceeds its effective range.) | Check the input type and range settings and correct them. |
| <i>uuu</i> UUU | PV under-scale (PV falls below its effective range.) | |
| Flashing period on PV display | Communication failure (for /RS option only) | Press any key to stop the flashing. |

(2) The controller needs to be repaired if any of the indications in the table below appear. In these cases, do not try to repair the controller yourself. Order a new controller or contact us for repair.

| Display | Error content | Display | Error content |
|--------------------------------|----------------------|---------------------------------|---|
| Unknown (at power-on) | CPU failure | Flashing Err (at power-on) | RAM or ROM failure |
| All extinguished (at power-on) | Power source failure | Flashing Err (during operation) | A/D converter failure, RJC failure, or EEPROM failure |
| Err (at power-on) | Calibration abnormal | | |

■ When Power Failure Occurred during Operation

● Momentary power failures of less than 20ms (or less than 1ms when “/V24” is specified) have no effect on the controller operation (i.e., normal operation continues).

● For power failures longer than 20ms (or longer than 1ms when “/V24” is specified), however the status will be as follows.

(The controller action at power recovery is the same as at power-on.)

- Alarm action: Continues (but alarms with a waiting action enter the waiting state once)
- Setting parameters: Maintained
- Auto-tuning: Canceled

8. INSTALLATION AND HARDWARE SPECIFICATIONS

8.1 Installation



CAUTION

To prevent electric shock, the source of power to the controller must be turned off when mounting the controller on to a panel.



NOTE

To install the controller, select a location where:

1. No-one may accidentally touch the terminals;
2. Mechanical vibrations are minimal;
3. Corrosive gas is minimal;
4. The temperature can be maintained at about 23°C with minimal fluctuation;
5. There is no direct heat radiation;
6. There are no resulting magnetic disturbances;
7. The terminal board (reference junction compensation element, etc.) is protected from wind;
8. There is no splashing of water; and
9. There are no flammable materials.

Never place the controller directly on flammable items.

If the controller has to be installed close to flammable items or equipment, be sure to enclose the controller in shielding panels positioned at least 150mm away from each side. These panels should be made of either 1.43mm thick metal-plated steel plates or 1.6mm thick uncoated steel plates.

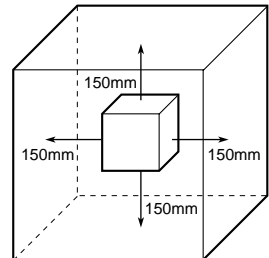

● **Mount the controller at an angle within 30° from horizontal with the screen facing upward. Do not mount it facing downward.**

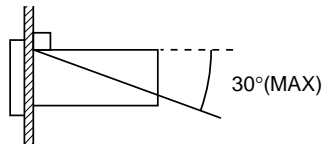



CAUTION

- 1) Before you start wiring, turn off the power source and use a tester to check that the controller and cables are not receiving any power in order to prevent electric shock.
- 2) Wiring should be carried out by personnel with appropriate electrical knowledge and experience.



IMPORTANT

- Always fix a terminal cover bracket to the UT130 and UT150 controllers before wiring if an optional tional anti-electric-shock terminal cover (part number: L4000FB) is used.
- Two types of optional anti-electric-shock terminal covers (part numbers: T9115YE and T9115YD) are available for the UT152 and UT155 controllers, respectively.

■ How to Mount UT130/UT150

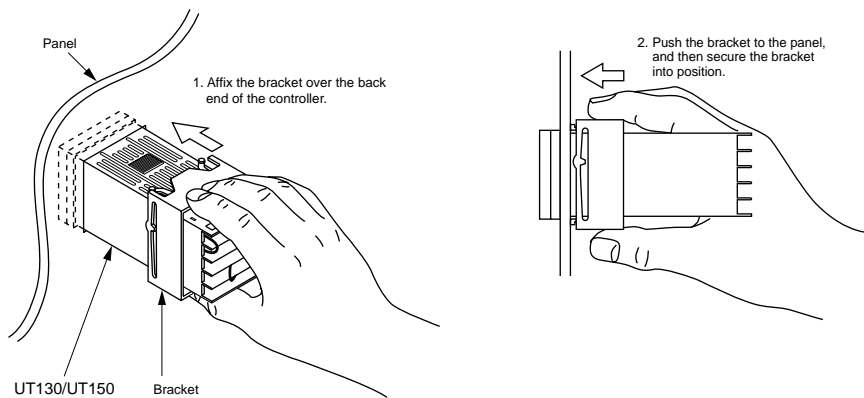

[How to remove the bracket]
To move the bracket, push down the center of the upper and lower parts of the controller softly. The bracket is released from the latch.

■ How to Mount UT152/UT155

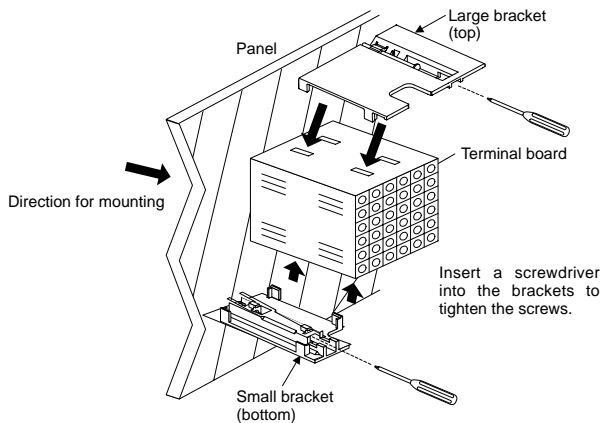

Insert the controller into the opening with the terminal board facing the front. Set and tighten the top and bottom brackets on the controller to fix it on the panel.

8.2 Panel Cutout Dimensions and External Dimensions

■ UT130 Panel cutout dimensions and external dimensions

1. General Mounting

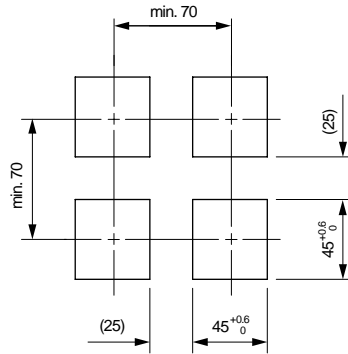

2. Side-by-side Close Mounting

(Splash-proof construction is unavailable)
*IP65 is unavailable.

Unit: mm

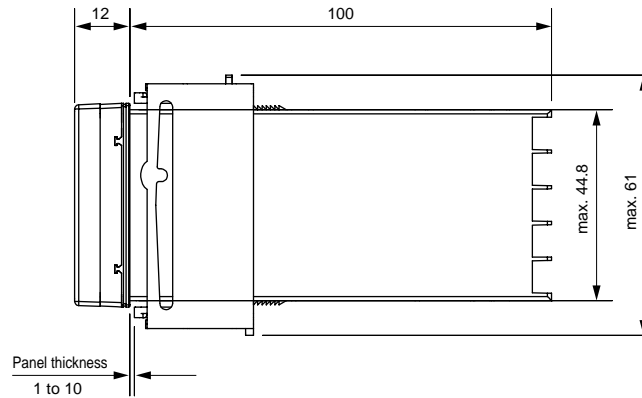
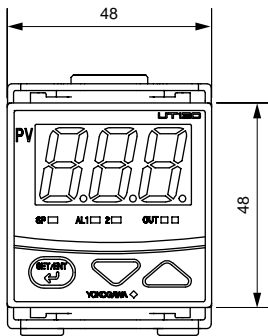
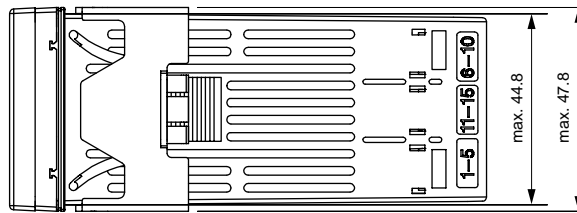
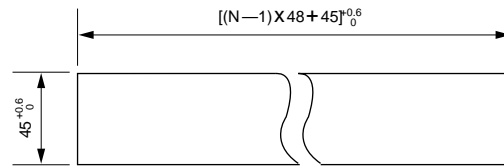

■ UT150 Panel cutout dimensions and external dimensions

1. General Mounting

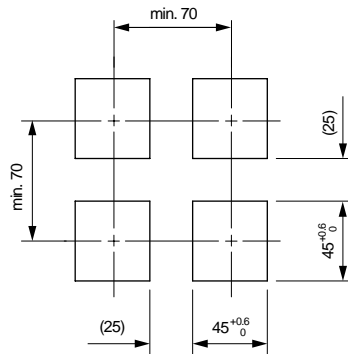

2. Side-by-side Close Mounting

(Splash-proof construction is unavailable)
*IP65 is unavailable.

Unit: mm

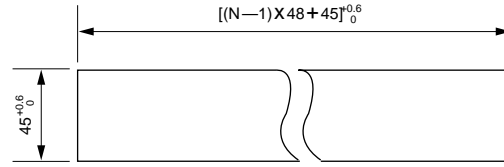

N is the number of controllers.
If $N \neq 5$, then measure the actual length.

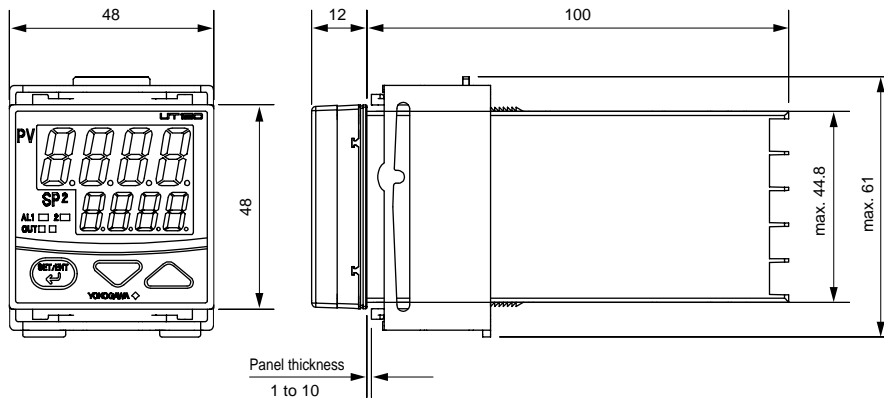
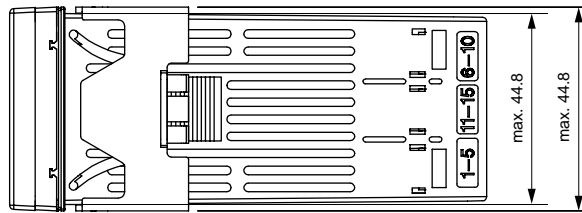

■ UT152Panel cutout dimensions and external dimensions

1. General Mounting

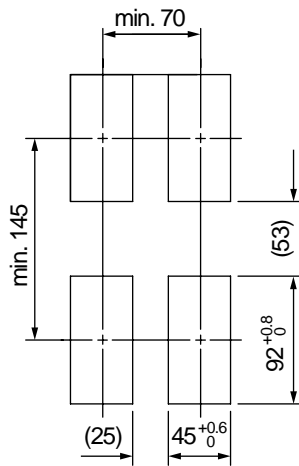

2. Side-by-side Close Mounting

(Splash-proof construction is unavailable)
*IP65 is unavailable.

Unit: mm

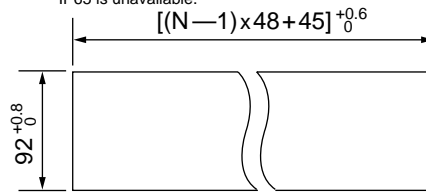

N is the number of controllers.
If $N \neq 5$, then measure the actual length.

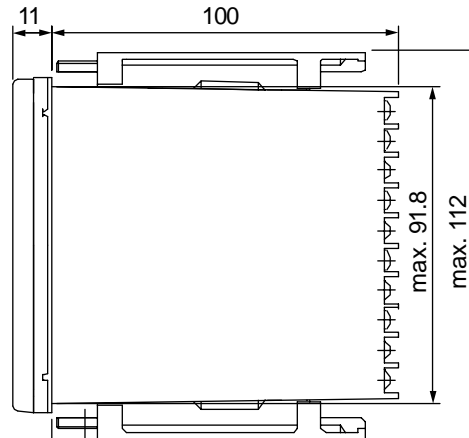
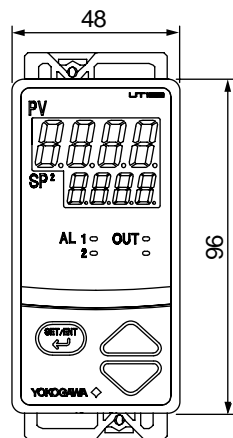
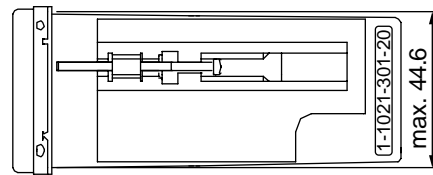

Panel thickness
1 to 10

■ UT155 Panel cutout dimensions and external dimensions

1. General Mounting

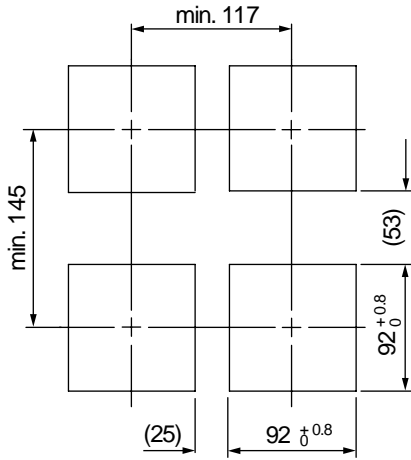

2. Side-by-side Close Mounting (Splash-proof construction is unavailable) *IP65 is unavailable.

Unit: mm

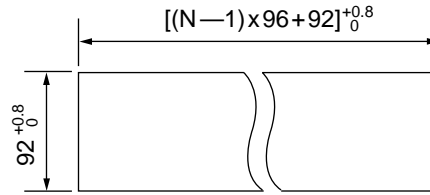

N is the number of controllers.
If N ≠ 5, then measure the actual length.

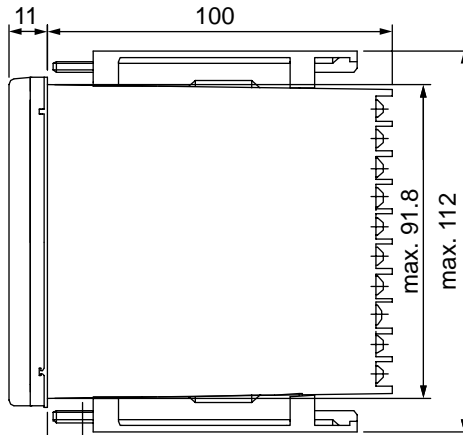
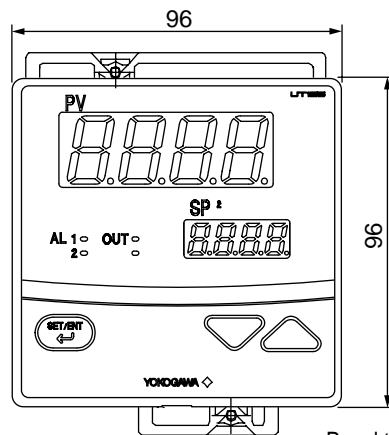
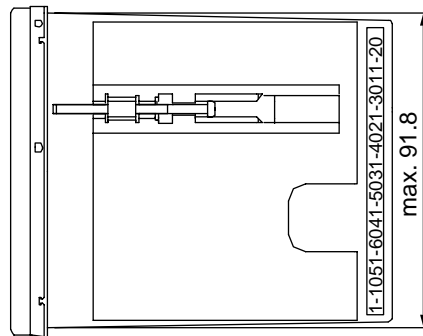

Panel thickness
1 to 10

8.3 Wiring



CAUTION

- 1) Before you start wiring, turn off the power source and use a tester to check that the controller and cables are not receiving any power in order to prevent electric shock.
 - 2) Wiring should be carried out by personnel with appropriate electrical knowledge and experience.
-



NOTE

- 1) Use a single-phase power source. If the source has a lot of noise, use an isolation transformer for the primary side and a line filter (we recommend TDK's ZAC2205-00U product) for the secondary side. When this noise-prevention measure is taken, keep the primary and secondary power cables well apart. Since the controller has no fuse, be sure to install a circuit breaker switch (of 5A and 100V AC or 220V AC, and that conforms to IEC standards) and clearly indicate that the device is used to de-energize the controller.
 - 2) For thermocouple input, use shielded compensating lead wires. For RTD input, use shielded wires which have low resistance and no resistance difference between the 3 wires. See the table given later for the specifications of the cables and terminals and the recommended products.
 - 3) The control output relay cannot be replaced even though it has a limited service life (100,000 relay contacts for the resistance load). Thus, an auxiliary relay should be used so that the load can be turned on and off.
 - 4) When using an inductive load (L) such as an auxiliary relay and solenoid valve, be sure to insert a CR filter (for AC) or diode (for DC) in parallel as a spark-rejecting surge suppressor to prevent malfunctions or damage to the relay.
 - 5) When there is the possibility of being struck by external lightning surge, use the arrester to protect the instrument.
-



IMPORTANT

Always fix a terminal cover bracket to the UT130 controller before wiring if an optional anti-electric-shock terminal cover (part number: L4000FB) is used.

Cable Specifications and Recommended Products

| | |
|---------------------------------------|---|
| Power supply and relay contact output | 600V vinyl insulated wire/cable, JIS C3307, 0.9 to 2.0mm ² |
| Thermocouple input | Shielded compensating lead wire, JIS C1610 |
| RTD input | Shielded wire (3-wire), UL2482 (Hitachi cable) |
| Other signals | Shielded wire |

Recommended Terminals

Use M3.5 screw-compatible crimp-on terminals with an insulating sleeve, as shown below.

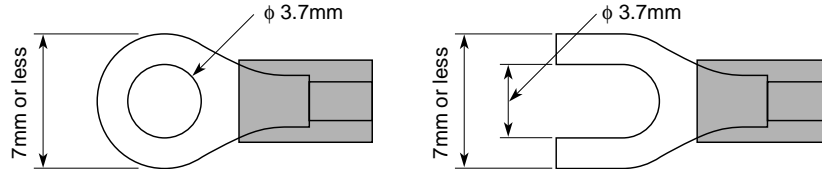

Standard Type

UT130 Terminal Arrangement (Standard Type)

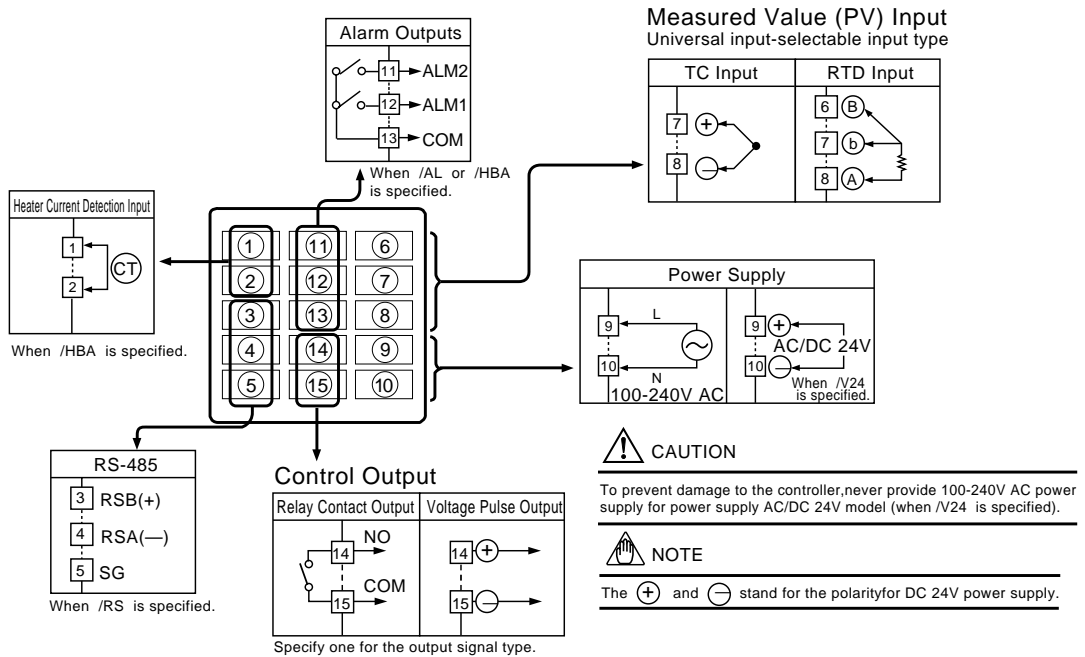

● UT150 Terminal Arrangement (Standard Type)

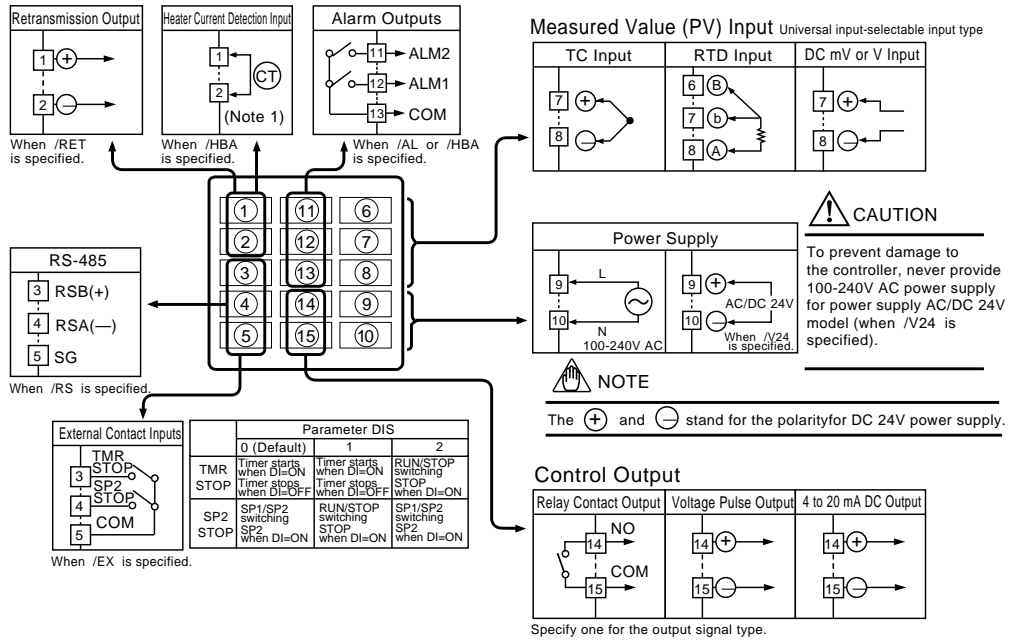

Note 1: The heater current detection input terminals (option code: /HBA) are defined as terminals 1 and 2 for a standard type and as terminals 3 and 4 for a heating/cooling type.

● UT152/155 Terminal Arrangement (Standard Type)

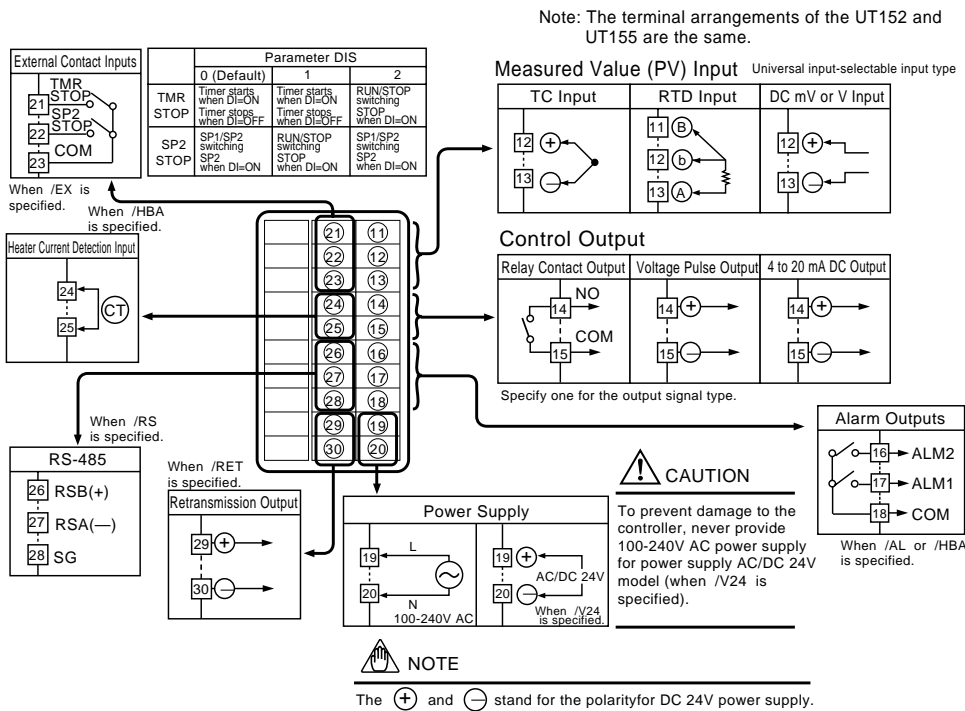

■ Heating/Cooling Type

● UT130 Terminal Arrangement (Heating/Cooling Type)

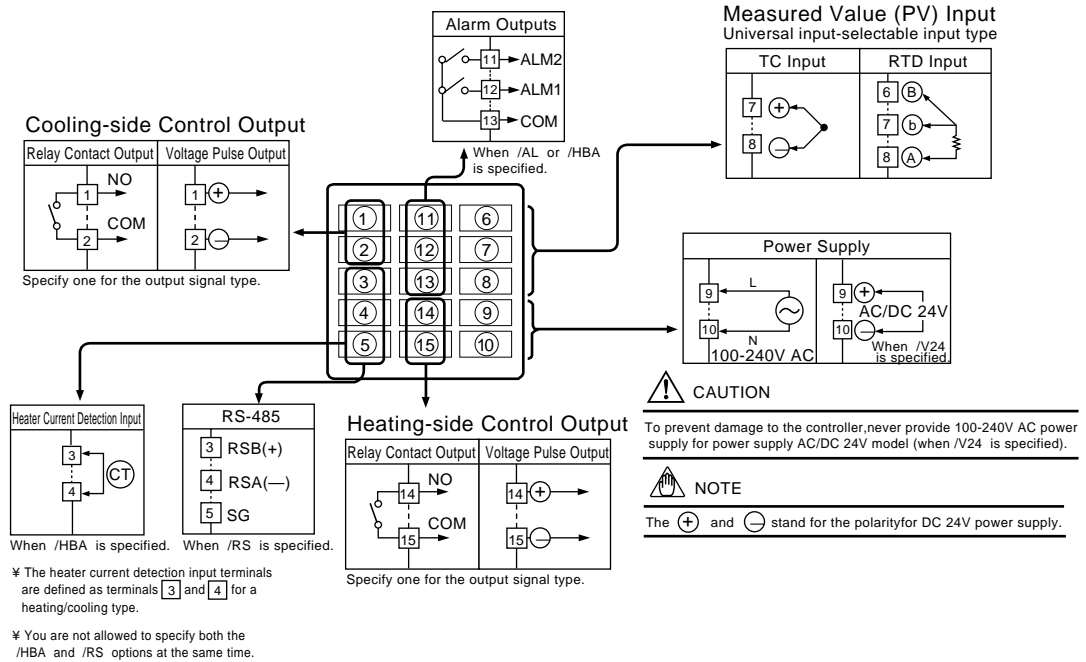

● UT150 Terminal Arrangement (Heating/Cooling Type)

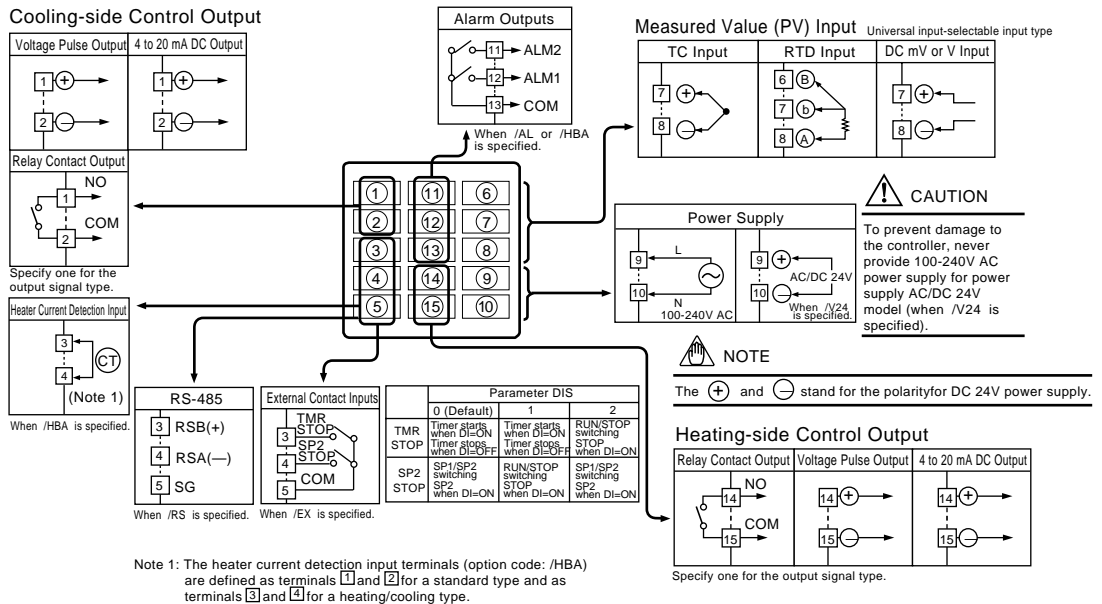

● UT152/155 Terminal Arrangement (Heating/Cooling Type)

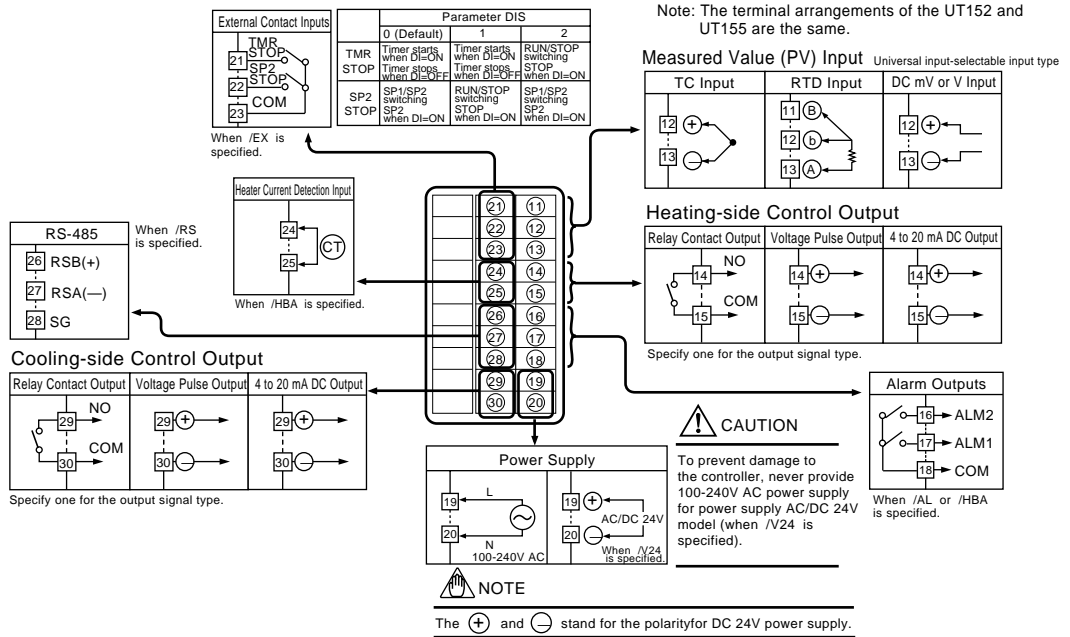

8.4 Hardware Specifications

Measured Value (PV) Input

- Input: 1 point
- Input type: Universal; can be selected by software
- Input accuracy (at 23–2°C ambient temperature)
 - Thermocouple: –2jC
 - However,
 - –4°C for thermocouple input –200 to –100°C
 - –3°C for thermocouple input –100 to 0°C
 - –5°C for types R and S (–9°C for 0 to 500°C)(For UT150/UT152/UT155 only)
 - –9°C for type B (accuracy is not guaranteed for 0 to 400°C)(For UT150/UT152/UT155 only)
 - RTD: –1°C –1digit
 - Voltage(mV, V) : –0.3% (For UT150/UT152/UT155 only)
- Sampling period for measured value input: 500ms
- Burn-out detection: Functions for thermocouple or RTD input (burn-out upscale only; cannot be switched off)
- Input resistance: 1M% or greater for thermocouple or DC mV input.
 - Approx. 1M% for DC V input (For UT150/UT152/UT155 only)
- Maximum allowable signal source resistance : 250% for thermocouple or DC mV input
 - 2k% for DC V input
- Maximum allowable wiring resistance for RTD input:
 - 10W/wire (The resistance values of three wires must be the same.)
- Allowable input voltage: –10V DC for thermocouple or DC mV input, –20V DC for DC V input(For UT150/UT152/UT155 only)
- Noise rejection ratio: Normal mode noise: Min. 40dB (50/60Hz) Common mode noise: Min. 120dB (Min. 90dB for DC V input) (For UT150/UT152/UT155 only)
- Error of reference junction compensation: –1.5°C (at 15–35°C), –2.0jC (at 0–50°C)
 - The reference junction compensation cannot be switched off.
- Applicable standards:
 - Thermocouple and resistance temperature detector JIS/IEC/DIN (ITS90)

Control Output

- Output: 1 point (for standard type) or 2 points (for heating/cooling type)
- Output type: Choose one from (1) to (3) below:
 - (1) Relay contact output
 - Contact capacity: 3A at 240V AC or 3A at 30V DC (with resistance load)
 - Note: The control output relay cannot be replaced by users.
 - (2) Voltage pulse output
 - On voltage: 12–18V DC
 - Off voltage: 0.1V DC or less
 - load resistance: 600W or greater
 - short-circuit current: approx. 30mA
 - (3) Current output (For UT150/UT152/UT155 only)
 - Output signal: 4 to 20mA
 - Maximum load resistance: 600%
 - Output accuracy: –0.3% of span (at 23–2°C ambient temperature)

Alarm Functions

Alarm Functions (Option Code /AL or /HBA)

- Alarm types: 22 types (waiting action can be set by software):
 - PV high limit, PV low limit, Deviation high limit, Deviation low limit, De-energized on deviation high limit, De-energized on deviation low limit, Deviation high and low limits, High and low limits within deviation, De-energized on PV high limit, De-energized on PV low limit, Fault diagnosis output, FAIL output
- Alarm output: 2 relay contacts
 - Relay contact capacity: 1A at 240V AC or 1A at 30V DC (with resistance load)
 - Note: The alarm output relays cannot be replaced by users.
- Heater Disconnection Alarm (Option Code /HBA)
 - The heater disconnection alarm is available when time-proportional PID control or on/off control is selected.
 - Heater current setting range: 1 to 80A
 - Alarm output: 1 relay contact
 - (The terminals are the same as those of the /AL option.)
 - On time of burn-out detection: Min. 0.2 second
 - Sensor: CTL-6-S-H or CTL-12-S36-8 (URD Co., Ltd.)
 - To be purchased separately.

Timer Function (Option Code /AL/EX or /HBA/EX)(For UT150/UT152/UT155 only)

- The output contact status changes when the preset time has passed since external contact (TMR) turned on.
- The contact action can be selected by software from:
 - (1) Make contact—the contact closes upon time-up.
 - (2) Break—the contact opens upon time-up.
- Input contact type: See the **Contact Inputs** below.

Retransmission Output (For UT150/UT152/UT155 only)

- The retransmission output is provided only when the /RET option is specified, but is not available for the heating/cooling type.
- Output signal: Measured value in 4–20mA DC
- Maximum load resistance: 600%
- Output accuracy: –0.3% of span (at 23–2°C ambient temperature)

Contact Inputs (For UT150/UT152/UT155 only)

- The contact inputs are provided only when the /EX option is specified.
- Functions: (1) SP1/SP2 switching
 - (2) Starting a timer (See the **Alarm Functions**.)
 - (3) RUN/STOP switching
 - Can be selected by parameter DIS.
- Input: 2 points (with the shared common terminal)
- Input type: Non-voltage contact or transistor contact input
- Contact capacity: At least 12V/10mA

Communication Function

The communication function is provided only when the /RS option is specified. (For details, read the instruction manual of the communications functions IM 05C01E12-10E.)

Communication Protocol

- Personal computer link: Used for communication with a personal computer, or UT link module of the FA-M3 controller (from Yokogawa Electric Corporation).
- Ladder communication: Used for communication with a ladder communication module of the FA-M3, or a programmable controller of other manufacturers.
- MODBUS communication: Used for communication with equipment featuring the MODBUS protocol.

Communication Interface

- Applicable standards: Complies with EIA RS-485
- Number of controllers that can be connected: Up to 31
- Maximum communication distance: 1,200m
- Communication method: Two-wire half-duplex, start-stop synchronization, non-procedural
- Baud rate: 2400, 4800, or 9600 bps

Safety and EMC Standards

- Safety: Confirms to IEC1010-1: 1990 and EN61010-1: 1992
 - Approved by CSA1010 for installation category CAT II (IEC1010-1), Certified for UL508
 - EMC standards: Complies with EN61326
- The UT130 and UT150 series temperature controllers conform to the standards specified under the following conditions.
 - All wires except those for the power supply and relay contact output terminals are shielded.
 - The controller does not fluctuate more than 20% even when noise is applied.

Power Supply and Isolation

Power Supply

| | | |
|---------------------------|--|---|
| Power supply | Voltage | Rated at 100-240VAC (–10%) AC/DC 24V when /N24 is specified. |
| | Frequency | 50/60Hz |
| Maximum power consumption | | 8VA max. (4W max.) 3W max. when /N24 is specified. |
| Memory | | Non-volatile memory |
| Withstanding voltage | Between primary terminals and secondary terminals (See notes 1 and 3.) | 1500V AC for 1 minute (See note 2.) |
| Insulation resistance | Between primary terminals and secondary terminals (See notes 1 and 3.) | 20M% or more at 500V DC |

- Note 1: The primary terminals are the power supply terminals and relay output terminals. The secondary terminals are the analog input and output terminals, the voltage pulse output terminals, and the contact input terminals.
- Note 2: The withstanding voltage is specified as 2300 V AC per minute to provide a margin of safety.
- Note 3: AC/DC 24V terminals are secondary terminals.

Isolation

The bold lines below indicate reinforced isolation, and the broken line indicates functional isolation.

| | |
|---|---|
| ● Power supply terminals (100–240V AC) | ● Power supply terminals AC/DC 24V (When /N24 is specified) |
| ● Control output terminals (relay contacts) | ● Measured value input terminals ● 2 input terminal for /EX |
| ● Alarm output terminals (2 relay contacts) | ● CT input terminals for /HBA ● Internal circuit |
| | ● Control output terminals: 4–20 mA/Voltage pulse |
| | ● RS-485 terminals for /RS |

Note: Neither the measured value input terminals, CT input terminals for the /HBA option, nor 2 input terminals for the /EX option are isolated from the internal circuit.

Construction, Mounting, and Wiring

- Construction: Splash-proof front panel (compliant with IP65 [Models UT130 and UT150] and IP55 [Models UT152 and 155]). Splash-proof construction is not available if the controller is mounted closely side-by-side.
- Casing: ABS resin and polycarbonate
- Case color: Black
- Mounting: Flush panel mounting
- Terminals: Screw terminals

Environmental Conditions

Normal Operating Conditions

- Warm-up time: At least 30 minutes
- Ambient temperature: 0–50°C (0–40°C when mounted side-by-side)
- Rate of change of temperature: 10°C/h or less
- Ambient humidity: 20–90% RH (no condensation allowed)
- Magnetic field: 400A/m or less
- Continuous vibrations of 5 to 14Hz: Amplitude of 1.2mm or less
- Continuous vibrations of 14 to 150Hz: 4.9m/s² (0.5G) or less
- Short-period vibrations: 14.7m/s² (1.5G) for 15 seconds or less
- Shock: 98m/s² (10G) for 11 milliseconds or less
- Mounting angle: Upward incline of up to 30 degrees; downward incline is not allowed.
- Altitude: 2000m or less above sea level

Maximum Effects from Operating Conditions

- (1) Temperature effects
 - Thermocouple, DC mV and DC V input: –2 V/°C or –0.02% of F.S./°C, whichever is larger
 - Resistance temperature detector: –0.05°C/°C
 - Analog output: –0.05% of F.S./°C
- (2) Effect from fluctuation of power supply voltage (within rated voltage range)
 - Analog input: –0.2 V/V or –0.002% of F.S./V, whichever is larger
 - Analog output: –0.05% of F.S./V

Transportation and Storage Conditions

- Temperature: –25 to 70°C
- Humidity: 5 to 95% RH (no condensation allowed)
- Shock: Package drop height 90cm (when packed in the dedicated package)