

2450 Pressure Sensors

3-2450.099 IE-7/031



Features

- S³L or 4 to 20mA Outputs
- Standard 3/4 in. NPT Process Connection or 1/2 in. Male Union
- One-piece injection molded PVDF body
- Flush ceramic diaphragm
- Easy Installation
- Three (3) Pressure Ranges

Application

- Level or Depth Sensing
- HVAC Systems
- Scrubbers
- Pump Protection
- Marine
- Water Management
- Irrigation Systems
- Wastewater
- Chem Processing
- Pressure Regulation/Monitoring

Description

The 2450 Pressure Sensor has a one-piece injection molded PVDF body and ceramic diaphragm for superior compatibility in corrosive liquids. Three (3) pressure versions allow for optimal resolution matched to your sensing needs. Solid state circuitry eliminates drift (no internal potentiometers.)

Built-in temperature compensation provides outstanding accuracy over wide temperature ranges. These sensors are

available with S³L (Signet Sensor Serial Link) digital output, or field-scaleable 4 to 20mA output. Dual threaded ends (3/4 in. NPT) allow submersion in process vessels, or in-line installation with conduit connection. Integral adapters (sold separately) may be used to create a compact assembly with field mount version of the +GF+ SIGNET 8450 Pressure Transmitter.

Options

	Instrument Options			
	S ³ L	4-20mA	1/2" Union	3/4" NPT
2450-1, -2, -3, -4	●	●	●	●
2450-5, -7	●	●	●	●

Technical Features

- S³L or 4 to 20mA output
- 4.5m (15 ft.) cable for remote installation, Model 3-2450-1X, -3X, -5X, -7X
- 152mm (6 in.) cable for integral installation, Model 3-2450-2X, -4X
- 3/4 in. NPT process connection
- One-piece injection molded PVDF body
- Flush ceramic diaphragm
- 1/2 in. Male Union (-3, -4 and -7)

Note: S³L output connects directly to +GF+ SIGNET instruments - see Options. 2450-5X, -7X provide S³L or 4 to 20mA output, depending on applied power.

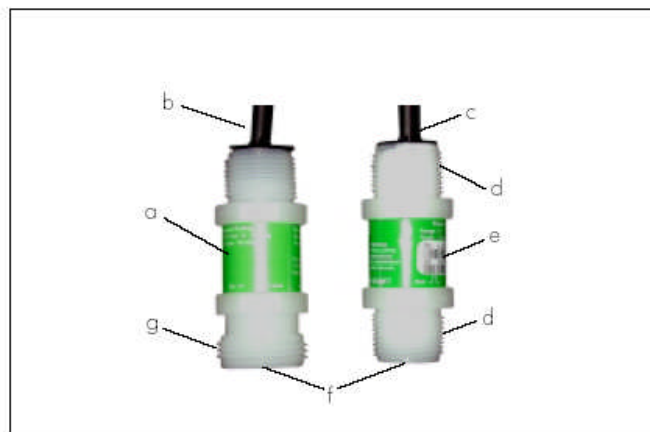

Dimensions

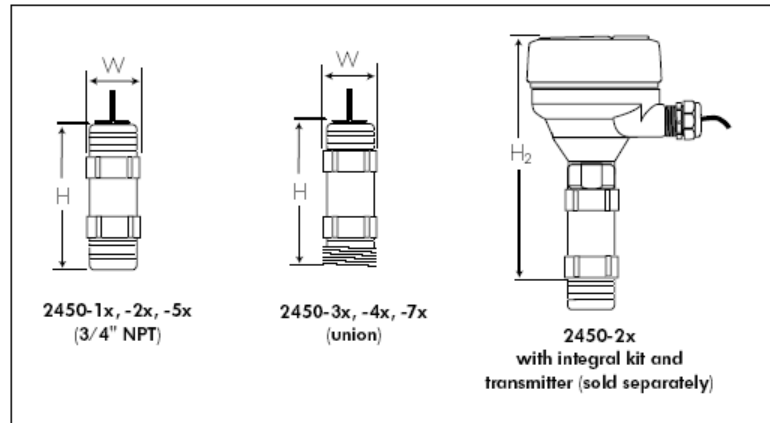

Units	W	H	H ₂
mm	34	81	197
inch	1.33	3.18	7.75

Installation

+GF+ SIGNET 2450 Pressure Sensors are gauge pressure sensors. Gauge pressure sensors measure the difference in pressure between the process on one side of a diaphragm and the atmospheric pressure on the opposite side of the diaphragm. Typically, a tiny capillary tube inside the sensor body is used to ensure that the back of the diaphragm remains at atmospheric pressure. If moisture is allowed to propagate down this tube to the rear of the diaphragm, damage to the sensor may occur. We offer the following installation tips.

In-line Integral

Use the 3-8052 Kit for Integral Mount to the 8450 Pressure Transmitter and 8250 Level Transmitter. Be sure to use a cable gland to guard against moisture intrusion.

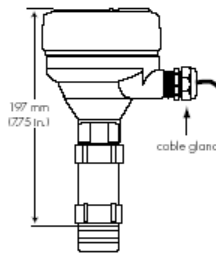

2450 with integral kit and transmitter (sold separately)

Submersible

Mount the sensor to an extension pipe or watertight conduit using thread sealant. Use a cable gland at the top end to prevent moisture intrusion/accumulation inside the pipe. DO NOT hermetically seal (i.e. applying silicone sealant or epoxy) the back of the sensor. To do so may introduce measurement errors resulting from changes in atmospheric pressure and/or temperature.

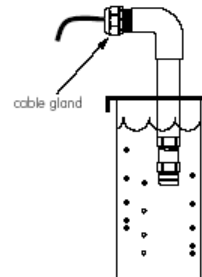

In-line Remote

Use 3/4 to 1/2 in. reducer coupling from sensor to cable gland. Finger tighten until fully secure and watertight.

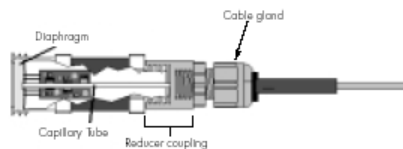

Wiring

S³L with Junction Box

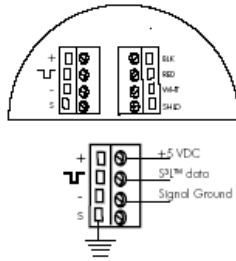

S³L without Junction Box

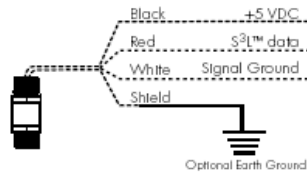

4 to 20mA Loop Wiring

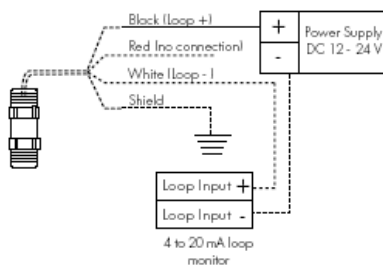

4 to 20mA Loop with Junction Box

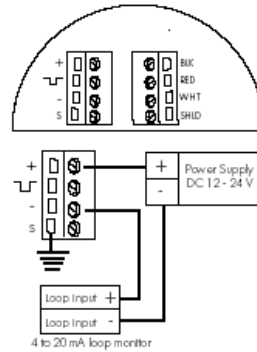

Specifications

General

Output: S³L (2450-1, -2, -3, -4)
4 to 20mA (2450-5, -7)
Accuracy: $\pm 1\%$ of full scale @
25°C
Response Time: <100ms

Power Requirements:

- S³L™: 4.5 to 6.5VDC <1.5mA
- 4 to 20mA: 9 to 26VDC

Wetted Materials:

- Sensor housing: PVDF
- Diaphragm: Ceramic
- Diaphragm seal: FPM

Process connection

- 1, -2, -5: 3/4 in. NPT male thread
- 3, -4, -7: 1/2 in. Union male thread

Conduit connection:

3/4 in. NPT male thread

Cable type:

3 cond + shield, 22 AWG,
Blk/ Red/White/Shld

Standard length:

- 2450-1, -3, -5, -7: 4.6m (15 ft.)
- 2450-2, -4: 15.2cm (6 in.)

S³L output: Serial ASCII, TTL level 9600
bps. Reverse polarity protected

Enclosure rating: NEMA 4X

4 to 20mA Output

Accuracy: $\pm 32\mu\text{A}$
Resolution: $< 5\mu\text{A}$
Span: 4 to 20mA factory calibrated to
ranges shown below
Max. Loop Impedance: 500 Ω @ 12V
325 Ω @ 18V
600 Ω @ 24V

Environmental

- Operating Temperature:
-15° to 85°C (5° to 185°F)
- Storage Temperature:
-20° to 100°C (-4° to 212°F)

Operational Range

Operating Pressure:

- XU 0 to 0.7 bar (0 to 10 psig)
- XL 0 to 3.4 bar (0 to 50 psig)
- XH 0 to 17 bar (0 to 250 psig)

Proof Pressure:

- XU 1.4 bar (20 psig)
- XL 5.2 bar (75 psig)
- XH 20.7 bar (300 psig)

Burst pressure: 82 bar (1,200 psig)

Standards and Approvals

- CE, CSA, UL listed
- EN 61326-2 Heavy Industry Immunity
- EN 55011 Class A Heavy Industry Emissions
- Manufactured under ISO 9001 and ISO 14001

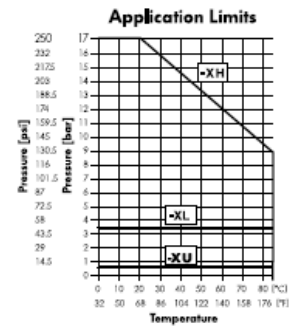

Ordering Information

Mfr. Part No.	Code	Description
3-2450-1U	159 000 679	0 to 10 psi, S ³ L, 3/4" male NPT, 15 ft. cable
3-2450-2U	159 000 680	0 to 10 psi, S ³ L, 3/4" male NPT, 6 in. cable
3-2450-3U	159 000 683	0 to 10 psi, S ³ L, 1/2" Male Union, 15 ft. cable
3-2450-4U	159 000 686	0 to 10 psi, S ³ L, 1/2" Male Union, 6 in. cable
3-2450-5U	159 000 905	10 psig, 4 to 20mA, 3/4 in., 15 ft. cable
3-2450-7U	159 000 906	10 psig, 4 to 20mA, 1/2 in., 15 ft. cable
3-2450-1L	159 000 024	0 to 50 psi, S ³ L, 3/4" male NPT, 15 ft. cable
3-2450-2L	159 000 025	0 to 50 psi, S ³ L, 3/4" male NPT, 6 in. cable
3-2450-3L	159 000 682	0 to 50 psi, S ³ L, 1/2" Male Union, 15 ft. cable
3-2450-4L	159 000 685	0 to 50 psi, S ³ L, 1/2" Male Union, 6 in. cable
3-2450-5L	159 000 907	50 psig, 4 to 20mA, 3/4 in., 15 ft. cable
3-2450-7L	159 000 908	50 psig, 4 to 20mA, 1/2 in., 15 ft. cable
3-2450-1H	159 000 026	0 to 250 psi, S ³ L, 3/4" male NPT, 15 ft. cable
3-2450-2H	159 000 027	0 to 250 psi, S ³ L, 3/4" male NPT, 6 in. cable
3-2450-3H	159 000 681	0 to 250 psi, S ³ L, 1/2" Male Union, 15 ft. cable
3-2450-4H	159 000 684	0 to 250 psi, S ³ L, 1/2" Male Union, 6 in. cable
3-2450-5H	159 000 909	250 psig, 4 to 20mA, 3/4 in., 15 ft. cable
3-2450-7H	159 000 910	250 psig, 4 to 20mA, 1/2 in., 15 ft. cable

Accessories

Mfr. Part No.	Code	Description
3-8052	159 000 188	3/4 in. Integral mounting kit
3-8052-1	159 000 755	3/4 in. NPT mount junction box
3-9000.392-1	159 000 839	Liquid tight connector kit, NPT (1 piece)
3-9000.392-2	159 000 841	Liquid tight connector kit, PG13.5 (1 piece)
5523-0322	159 000 761	Sensor cable (per ft.), 3 conductor + shield 22 AWG, Blk/Red/White/Shld

Pathfinder Instruments, LLC

2075 Corte Del Nogal, Suite X
Carlsbad, Ca 92011

Ph: 800-284-9698 / Fax: 760-438-3953

Email: info@pathfinderinstruments.com

Website: www.pathfinderinstruments.com